

# Switching Costs and Network Compatibility\*

Jiawei Chen<sup>†</sup>

November 28, 2017

## Abstract

This paper investigates how consumer switching costs affect firms' compatibility choices and social welfare in network industries. Firms face a choice between two modes of competition: make their networks incompatible and compete fiercely for market dominance, or make their networks compatible and have mild competition. By incentivizing firms to harvest their locked-in consumers rather than price aggressively for market dominance, switching costs tip the balance in favor of compatible networks and mild competition. A public policy that reduces switching costs also tends to make networks incompatible, and results in small efficiency gains at best. Combining the policy with a mandatory compatibility policy, however, can lead to sizable efficiency gains.

*Keywords:* switching costs, network compatibility, industry dynamics, welfare

---

\*I thank Jan Brueckner, Luis Cabral, Yongmin Chen, Linda Cohen, Darren Filson, Amihai Glazer, Lukasz Grzybowski, Lingfang Li, Guofu Tan, Zhu Wang, and seminar participants at International Industrial Organization Conference (Boston), Econometric Society World Congress (Montreal), European Economic Association Annual Congress (Mannheim), EARIE Annual Conference (Munich), University of Nevada, Reno, Workshop on Antitrust and Industrial Organization (Shanghai University of Finance and Economics), Fudan University, and Claremont McKenna College for their helpful comments. I thank the NET Institute for financial support. Finally, I am grateful to the editor and two anonymous reviewers for their constructive suggestions.

<sup>†</sup>Department of Economics, 3151 Social Science Plaza, University of California, Irvine, CA 92697-5100. E-mail: jiaweic@uci.edu.

# 1 Introduction

A product or service has network effect if its value to a consumer increases in the number of its users. For example, with mobile phone services, there are typically discounts for on-net calls, and therefore a user benefits from being in a network with more users, because in that case the user is more likely to be making on-net calls and paying discounted calling fees. Similarly, with banking services, a bank that has more customers typically has more extensive branch and ATM networks, which make it easier for customers to access their accounts wherever they happen to be.

Two prominent features of network industries are consumers' switching costs and firms' compatibility choices. First, consumers can switch between networks but it is often costly for them to do so (in terms of money and/or effort). For example, when a consumer switches from one mobile phone service provider to another, she needs to tell her new phone number to all her contacts (if phone numbers are not portable between two different providers), and she may have to pay early termination fees. Similarly, when a consumer switches from one bank to another, she needs to tell her new bank's name and her new account number to all the relevant parties (direct deposits, automatic payments, etc.). In fact, Shy (2001, Page 1) states that switching costs are one of the main characteristics of network industries.

Second, firms sometimes make their networks compatible—here compatibility between two networks refers to the ability of consumers in either network to enjoy the network effect from both networks.<sup>1</sup> For example, mobile phone service providers may extend their on-net calling discounts to cover each other's networks, and banks may allow their customers to access their combined ATM networks without extra fees.

Although each of the above two features of network industries has been analyzed in the literature, the interactions between them remain largely unexplored. Yet such interactions play an important role in determining the industry dynamics and market outcome. Here's a real-world example. In 1999, mobile number portability was implemented in Hong Kong, which enabled mobile phone users to retain their mobile phone numbers when changing from one carrier network to another, thereby reducing consumers' switching costs. In response to this policy, the mobile phone carriers in Hong Kong reduced the compatibility among their networks (shared on-net calling discounts) by adopting network-based discriminatory pricing schemes. Following the implementation of mobile number portability, the market prices went down, and moreover, the largest network steadily gained market share, resulting in a higher level of market concentration (Shi, Chiang, and

---

<sup>1</sup>In the case of direct network effects, compatibility means consumers in either network can freely interact with consumers in the other network. In the case of indirect network effects, compatibility means the complementary product for either network can be used on the other network.

Rhee (2006)).

To better understand such interactions and their impact on industry dynamics and welfare, in this paper I investigate the effects of switching costs on network compatibility using a dynamic duopoly model with an infinite horizon. In each period, firms choose both network compatibility and prices. I numerically solve for a Markov perfect equilibrium of the model, and study how switching costs affect firms' compatibility choices and social welfare.

I find that switching costs tend to induce compatible networks. Firms face a choice between two modes of competition: make their networks incompatible and compete fiercely for market dominance, or make their networks compatible and have mild competition. By incentivizing firms to harvest their locked-in consumers rather than price aggressively for market dominance, switching costs tip the balance in favor of compatible networks and mild competition. This result points to an important tradeoff in network industries between consumer mobility and product compatibility: when switching costs—the barrier to consumer mobility—are reduced, the firms tend to reduce the compatibility between their networks.

Correspondingly, in welfare analysis I find that in a network industry with high switching costs, a public policy that reduces switching costs, by itself, does not lead to a significant increase in total surplus, as the efficiency gains from lowering switching costs are offset by the efficiency losses from firms reducing the compatibility between their networks. However, if the switching costs reduction policy is combined with a public policy that mandates compatibility between networks (for an example of such policies, see Hannan (2007), which studies ATM surcharge bans), then there are sizable efficiency gains, as such a combination makes it possible to have the best of both worlds—low switching costs and compatible networks.

Analysis of how switching costs affect firms' strategic choices and the market outcome is particularly needed in light of the recent growing trend of regulations that aim at reducing switching costs in network industries in order to increase competition. For instance, in the past decade or so, mobile number portability was implemented in more than forty countries to reduce mobile phone users' switching costs. In the EU retail banking and payments systems markets, the European Competition Authorities Financial Services Subgroup recommends the implementation of switching facilities (objective and up-to-date comparison sites, switching services, etc.) and account number portability to lower switching costs (ECAFS (2006)). While there are many studies on the effects of switching costs on market concentration and prices, little is known about how a change in switching costs affects firms' network compatibility choices (shared on-net calling discounts, shared ATM networks, etc.) Since network compatibility can have significant impact on competition and welfare, research on this issue is much needed.

**Related Literature.** One of the main findings in the literature on switching costs is that they make markets less concentrated (see, for example, Beggs and Klemperer (1992), Chen and Rosenthal (1996), Taylor (2003), and Chen (2016)). Adding to that literature, the current paper examines the effects of switching costs in network industries on both the market structure and firms' compatibility choices, and shows that switching costs tend to induce compatible networks, which go hand in hand with a lower level of market concentration.

Shi, Chiang, and Rhee (2006) study the effects of mobile number portability in a one-period model. They find that by reducing consumers' switching costs, mobile number portability leads to lower prices and higher market concentration. In their model, the firms use the same network-based discriminatory pricing schemes regardless of the level of switching costs; in other words, changes in the switching costs have no effect on the firms' network compatibility choices. The current paper extends the analysis by incorporating dynamics, and shows that firms' compatibility choices crucially depend on the level of switching costs, and furthermore, changes in the firms' compatibility choices have important implications for welfare.<sup>2</sup>

A number of existing papers investigate whether compatibility will emerge in a standard two-stage model without switching costs: in the first stage, firms make compatibility decisions, and then given such decisions, they engage in price or quantity competition. Examples include Katz and Shapiro (1986), Economides and Flyer (1997), Cremer, Rey, and Tirole (2000), Malueg and Schwartz (2006), and Tran (2006). These papers find that products are made compatible when firms are comparable in terms of their installed bases or some other traits.

To go beyond the initial emergence of compatibility and take account of the evolution of the market over time, one needs to study the long-run industry dynamics. A growing body of work explores long-run market structure issues in network industries, such as Mitchell and Skrzypacz (2006), Llobet and Manove (2006), Driskill (2007), Markovich (2008), and Cabral (2011), although they do not model firms' compatibility choices.

Chen, Doraszelski, and Harrington (2009) endogenizes product compatibility in a dynamic stochastic setting and investigates the issue of whether compatibility can be maintained in the long run. They find that products are compatible when firms have similar installed bases, and when random forces result in one firm having a bigger installed base, strategic pricing tends to prevent the installed base differential from expanding to the point that incompatibility occurs. Their paper does not consider consumer switching costs.

---

<sup>2</sup>In a related paper, though not in the context of switching costs, Farrell and Saloner (1986) also study the implications of compatibility on welfare. The focus of their paper is on the tradeoff between standardization (compatible products) and variety. They find that if standardization is the unique equilibrium, then it also maximizes welfare. However, if there exist multiple equilibria, then it is possible that an equilibrium involves standardization when the optimum involves variety.

Chen (2016) investigates the effects of switching costs in network industries using a dynamic model of price competition, and provides a series of results that characterize how switching costs affect market concentration and prices in network industries. The paper does not consider firms' compatibility choices.

The current paper adds to the above literature by incorporating consumer switching costs into a dynamic model in which firms make both compatibility and price decisions. This allows me to study the long-run effects of switching costs on firms' compatibility choices and social welfare and examine the policy implications.

This paper also joins a growing literature that uses computational dynamic oligopoly equilibrium models to derive policy implications. For example, Gowrisankaran and Town (1997) investigate the effects of changes in health care policies and taxation of nonprofits using a dynamic model of the hospital industry. Benkard (2004) studies the effects of an antitrust policy that restricts concentration in the commercial aircraft industry. Tan (2006) analyzes how anti-smoking policies affect the market structure of the U.S. cigarette industry. Ching (2010) studies the welfare effects of shortening the expected generic approval time in the prescription drug market. Filson (2012) examines the consequences if the U.S. adopts price controls or one or more non-U.S. countries abandon their controls in the pharmaceutical industry.

The rest of the paper is organized as follows. The next section presents the model. Section 3 reviews the dynamic equilibria of the model. Section 4 discusses the effects of switching costs on the equilibrium outcome. Section 5 examines the welfare effects of two public policies related to switching costs and network compatibility. Section 6 concludes.

## 2 Model

This section describes a dynamic duopoly model of network industries in which firms have the option to make their networks compatible and consumers face switching costs. This model builds on Chen, Doraszelski, and Harrington (2009) and Chen (2016), and adds the interaction between switching costs and network compatibility. Since the objective of this paper is to provide some general insights about how switching costs affect firms' compatibility choices and social welfare, the model is not tailored to any particular industry. Instead, a more generic model is developed to capture the key features of many network markets featuring consumers' switching costs and firms' compatibility choices.

## 2.1 State Space and Firm Decisions

The model is cast in discrete time with an infinite horizon. Two firms sell to a sequence of buyers with unit demands. Each firm sells a single product and sets price. The firms' products are referred to as the inside goods, and are durable subject to stochastic death. There is also an outside good (“no purchase”), indexed 0. The outside good (also called “outside alternative” or “outside option” in the literature) refers to the no-purchase option.<sup>3</sup> In the model, what this outside good does is that it makes the so called “market coverage” endogenous, i.e., with an outside good, the combined market share of the firms is endogenously determined. In comparison, in models without such an outside good, the firms' combined market share is exogenously fixed at 100% (the “full market coverage” assumption).

At the beginning of period  $t$ , a firm is endowed with an installed base which represents users of its product.  $b_{it} \in \{0, 1, \dots, M\}$  denotes the installed base of firm  $i$  in period  $t$ , where  $M$  represents the size of the consumer population and is the upper bound on the *sum* of the firms' installed bases.  $b_{0t} = M - b_{1t} - b_{2t}$  is the outside good's “installed base”, though it does not offer network benefits. The industry state is  $b_t = (b_{1t}, b_{2t})$ , with state space  $\Omega = \{(b_{1t}, b_{2t}) | 0 \leq b_{it} \leq M, i = 1, 2; b_{1t} + b_{2t} \leq M\}$ .

Assume that the firms employ stationary strategies, i.e., their strategies are not explicitly a function of time  $t$ . Given stationarity, in the rest of the paper I drop the time subscript  $t$ , and use the prime symbol ( $'$ ) to denote next-period values. For example, in what follows,  $b = (b_1, b_2)$  denotes the state in the current period, and  $b' = (b'_1, b'_2)$  denotes the state in the next period.

In each period, given  $(b_1, b_2)$ , the firms engage in a two-stage game, choosing compatibility in the first stage and prices in the second stage. In the first stage, each firm decides whether or not to “propose compatibility” with the other firm. Let  $d_i \in \{0, 1\}$  be the compatibility choice of firm  $i$ , where  $d_i = 1$  means “propose compatibility.” Products of the two firms are “compatible” if and only if  $d_1 \cdot d_2 = 1$ . After compatibility is determined and revealed to the firms, they simultaneously choose prices in the second stage. In Subsection 2.4 below, I provide a more detailed discussion of how this two-stage game in each period fits into the Markov perfect equilibrium framework.

The compatibility studied in this paper is two-way compatibility, which allows consumers on both networks to get bigger network benefits. In the real world, in some cases compatibility is two-way, and in some cases it is one-way (which expands the network benefits for consumers on one network only). As an example of two-way compatibility, in the streaming media industry,

---

<sup>3</sup>The modeling of an outside good is a commonly used approach in the discrete choice literature. For instance, Anderson, de Palma, and Thisse (1992, p. 80) gives the following example to illustrate the outside good: in the context of choosing a restaurant, the inside goods are the different restaurants, while the outside good may be “eating at home”. Note that the outside good does not refer to money or a medium of exchange, and furthermore, a consumer who buys one of the inside goods does not choose the outside good.

Apple’s QuickTime and Microsoft’s Windows Media Player can playback and save in each other’s proprietary format, allowing users of either piece of software to enjoy the network benefits from both networks. In contrast, in the late 80’s, Apple Computers installed the so called “HyperDrive” diskette drive on their Macintosh computers, which allowed Macintosh users to read DOS-formatted diskettes produced on Intel-based computers, but files on Macintosh-formatted diskettes were not readable on Intel-based DOS computers. This is an example of one-way compatibility (see Manenti and Somma (2002) for a discussion of these and several other examples of two-way and one-way compatibility). This paper focuses on two-way compatibility and abstracts from one-way compatibility.

## 2.2 Consumers

Following prior studies on industry dynamics in network markets, such as Chen, Doraszelski, and Harrington (2009) and Cabral (2011), I assume that demand in each period comes from one random consumer. This consumer chooses one among the three goods.  $r \in \{0, 1, 2\}$  denotes the good that this consumer is loyal to. A consumer may be loyal to a firm’s product because she previously used that product and now her product dies and she returns to the market.<sup>4</sup> Assume  $r$  is distributed according to  $\Pr(r = j|b) = b_j/M$ ,  $j = 0, 1, 2$ , so that a larger installed base implies a larger expected demand from loyal consumers.

**Utility Functions.** Below I first present the consumers’ utility functions, and then explain them. For the consumer who makes a purchasing decision in the current period, assuming that she is loyal to good  $r$ , the utility that she gets from buying good  $i$  is

$$u_{ri}(b, d, p) = v_i + \mathbf{1}(i \neq 0)\theta g(b_i + d_1 d_2 b_{-i}) - p_i - \mathbf{1}(r \neq 0 \text{ and } i \neq 0 \text{ and } i \neq r)k + \epsilon_i. \quad (1)$$

Besides this purchase-decision-making consumer, the rest of the consumers do not make a purchasing decision in the current period and simply use the products that they have (for those whose products died and who do not make a purchasing decision, assume that they use the outside good).<sup>5</sup> These consumers do not pay a price, and do not incur switching costs. The utility that

<sup>4</sup>In this paper, I assume product deaths but not consumer deaths, and therefore this is a model with no newly-entering consumers.

<sup>5</sup>In this model, a consumer who has purchased before does not return to the market and make another purchasing decision until her product dies. This assumption follows the approach in prior studies such as Beggs and Klemperer (1992), Chen, Doraszelski, and Harrington (2009), and Cabral (2011), which assume that in a durable goods market, purchasing decisions are made only when an existing product dies, or when a consumer dies and is replaced with a new consumer.

such a consumer gets, assuming that she uses product  $i$ , is

$$w_i(b, d) = v_i + \mathbf{1}(i \neq 0)\theta g(b_i + d_1 d_2 b_{-i}) + \epsilon_i. \quad (2)$$

These consumers who do not make a purchasing decision in the current period do not contribute to the demand in the current period, but the expression for  $w_i$ , along with the expression for  $u_{ri}$ , will be useful when we compute consumer surplus later in the paper.

In the above two equations,  $v_i$  is the intrinsic product quality, which is fixed over time and is common across firms:  $v_i = v$ ,  $i = 1, 2$ . Since the intrinsic quality parameters affect demand only through the expression  $v - v_0$ , without loss of generality I set  $v = 0$ , and consider different values for  $v_0$ .

$b_i + d_1 d_2 b_{-i}$  is the effective installed base of firm  $i$  given the compatibility choices, where  $b_{-i}$  is the installed base of firm  $i$ 's rival. The increasing function  $\theta g(\cdot)$  captures network effects, where  $\theta \geq 0$  is the parameter controlling the strength of network effect.<sup>6</sup> There are no network effects associated with the outside good. The results reported below are based on linear network effects, that is,  $g(b_i) = b_i/M$ . I have also allowed  $g$  to be convex, concave, and S-shaped, and the main results are robust.

$p_i$  denotes the price for good  $i$ . The price of the outside good,  $p_0$ , is always zero.

The nonnegative constant  $k$  denotes switching cost, and is incurred if the consumer switches from one inside good to the other. A consumer who switches from the outside good to an inside good incurs a start-up cost, which is normalized to 0. Increasing the start-up cost above 0 has the effect of lowering the inside goods' intrinsic quality relative to that of the outside good.

$\epsilon_i$  is the consumer's idiosyncratic preference shock and is assumed to have zero mean.  $(\epsilon_0, \epsilon_1, \epsilon_2)$  and  $r$  are unknown to the firms when they set prices.

**Choice Probabilities.** Assume  $\epsilon_i$  is distributed type I extreme value, independent across products, consumers, and time. We then have a logit model for the consumer who makes a purchasing decision. The probability that a consumer who is loyal to good  $r$  buys good  $i$  is thus

$$\phi_{ri}(b, d, p) = \frac{\exp(v_i + \mathbf{1}(i \neq 0)\theta g(b_i + d_1 d_2 b_{-i}) - p_i - \mathbf{1}(r \neq 0 \text{ and } i \neq 0 \text{ and } i \neq r)k)}{\sum_{j=0}^2 \exp(v_j + \mathbf{1}(j \neq 0)\theta g(b_j + d_1 d_2 b_{-j}) - p_j - \mathbf{1}(r \neq 0 \text{ and } j \neq 0 \text{ and } j \neq r)k)}, \quad (3)$$

---

<sup>6</sup>Note that the network effects are based on the installed bases at the beginning of the period, i.e., before the purchase-decision-making consumer chooses her product. One motivation for this specification is that when network effects come from a complementary stock which increases the value of the network, it often takes time for the developers to build up this complementary stock (Llobet and Manove (2006)). For example, the network of users of a computer operating system benefit from the complementary stock of software applications; since the development of these software applications takes time, the size of this complementary stock is proportional to the size of the installed base with a lag.



where  $b$  is the vector of installed bases,  $d$  is the vector of compatibility choices, and  $p$  is the vector of prices.

**The Assumption of Myopic Consumers.** In this model, the consumer buys the good that offers the highest current utility. I am then assuming that consumers make myopic decisions, which is a limitation of the present study. While in some durable goods markets there is evidence that consumers behave myopically (for example, see Miao (2010) for evidence in the printer and cartridge market), in some other durable goods markets there is evidence that consumers do not behave myopically (for example, see Busse, Knittel, and Zettelmeyer (2013) for evidence in the automobile and gasoline market). A more general model would allow the possibility that consumers are forward-looking, and ideally also vary the degree to which consumers are forward-looking to assess how the results are affected. The parsimonious specification of consumers' decision-making in this paper allows rich modeling of firms' choices and industry dynamics. Allowing consumers to be forward-looking with rational expectations in the presence of network effects, switching costs, and compatibility decisions is an important but challenging extension of the current work.

**Real-World Examples of Switching Costs and Network Compatibility.** In this model, switching costs are unchanged when firms make their networks compatible, which fits the reality in some real-world industries.

Consider, for instance, ATM networks in the banking industry, which provide a good example for a market featuring network effects and firms' compatibility decisions (Shy (2001, pp. 196-197)). A bank with a larger customer base can afford to install and operate a larger ATM network. Therefore, its customers benefit from a larger number of geographically dispersed ATMs, which make it easier for customers to access their accounts wherever they happen to be. Two banks can make their ATM networks compatible by allowing consumers from each network to access the ATMs in the other network for free. Note that when two banks make their ATM networks compatible, a consumer who switches from one bank to the other still incurs the switching cost as she still needs to inform all the relevant parties (direct deposits, automatic payments, etc.) of her new account number.

As another example, consider mobile phone networks, which feature the so-called tariff-mediated network effects (Laffont, Rey, and Tirole (1998)): mobile phone service providers often provide "on-net" calling discounts, which are reduced calling rates offered to customers for calling others on the same network. They may take the form of lower rates for on-net calls, or a certain number of "free" on-net minutes as part of a subscription package; see Shi, Chiang, and Rhee (2006) and Zucchini, Claussen, and Trg (2013) for examples in Hong Kong and Germany, respectively. Two mobile

service providers can make their networks compatible by extending their on-net calling discounts to cover each other's network. Note that when two providers make their networks compatible, a consumer who switches from one network to the other still faces the switching cost as she still needs to pay the early termination fee and incur procedural costs such as setting up automatic bill payments with the new provider.

In some other cases, switching costs may be reduced when firms make their products compatible. For example, if two producers of computer-aided design (CAD) software (which many engineers use to design structures/models) make their products compatible by adopting the same standard, a consumer who switches will incur smaller switching costs: while she still needs to incur learning costs, due to the compatibility she no longer needs to convert her old files to a new format in order to use them within the new software. This paper focuses on the first type of switching costs (unchanged when networks are made compatible), and leaves the more general case which encompasses both types of switching cost to future work.

### 2.3 Depreciation and Transition

In each period, each unit of a firm's installed base independently depreciates with probability  $\delta \in [0, 1]$ , due to product death. Let  $\Delta(x_i|b_i)$  denote the probability that firm  $i$ 's installed base depreciates by  $x_i$  units. We have

$$\Delta(x_i|b_i) = \binom{b_i}{x_i} \delta^{x_i} (1 - \delta)^{b_i - x_i}, \quad x_i = 0, \dots, b_i, \quad (4)$$

as  $x_i$  is distributed binomial with parameters  $(b_i, \delta)$ . Accordingly  $E[x_i|b_i] = b_i\delta$ , and therefore the expected size of the depreciation to a firm's installed base is proportional to the size of that installed base. When the firms' installed bases depreciate, the number of unattached consumers,  $b_0 = M - b_1 - b_2$ , goes up by the same number as the aggregate depreciation, and the total market size is fixed (at  $M$ ).

Let  $q_i \in \{0, 1\}$  indicate whether or not firm  $i$  makes the sale. Firm  $i$ 's installed base changes according to the transition function

$$\Pr(b'_i|b_i, q_i) = \Delta(b_i + q_i - b'_i|b_i), \quad b'_i = q_i, \dots, b_i + q_i. \quad (5)$$

If the joint outcome of the depreciation and the sale results in an industry state outside of the state space, the probability that would be assigned to that state is given to the nearest state(s) on the boundary of the state space.

## 2.4 Markov Strategies and Bellman Equation

In this model, there are two stages in each period. The firms simultaneously make compatibility decisions in the first stage, then simultaneously make price decisions in the second stage.

In the Markov perfect equilibrium framework, prior studies have used similar settings in which there is a two-stage game in each period in an infinite-horizon model. For instance, in the infinite-horizon model in Fershtman and Pakes (2000), there are two stages in each period. In the first stage, the incumbents decide whether or not to exit and a potential entrant decides whether or not to enter, and in the second stage, the remaining firms simultaneously choose price and investment. A similar two-stage structure is also used in Chen, Doraszelski, and Harrington (2009), among others. In all of these papers, in each period, the firms make their second-stage decisions after the first-stage decisions are known.

**Markov Strategies.** A Markov strategy is one that depends only on state variables that summarize the history of the game. In the current model, the industry state  $b$  is a summary of the final outcomes of the sequence of two-stage games prior to this period. A Markov strategy for a firm is a function that maps from the state space  $\Omega$  into  $D \times F$ , where  $D = \{0, 1\}$  is the set of compatibility choices and  $F$  is the set of the price policy functions, where a price policy function  $f_i$  maps from  $\Omega \times D^2$  into  $\mathbb{R}$ ; that is, given the state and the firms' compatibility choices,  $f_i$  prescribes a price for firm  $i$ .

In equilibrium, since the compatibility policy functions are functions of the state, the price policy functions, being functions of the state and the compatibility choices, can be expressed as functions of the state alone.

**Bellman Equation.** Below I first present the Bellman equation, and then explain it. For each  $b$  in the state space  $\Omega$ , the value of firm  $i$  satisfies

$$V_i(b) = \max_{d_i \in \{0, 1\}} U_i(b, d_i, d_{-i}(b)), \quad (6)$$

where

$$U_i(b, d) = \max_{p_i} E_{r|b} \left\{ \phi_{ri}(b, d, p_i, p_{-i}(b, d)) p_i + \beta \sum_{j=0}^2 \left[ \phi_{rj}(b, d, p_i, p_{-i}(b, d)) \sum_{b' \in \Omega} [\Pr(b'|b, q_j = 1) V_i(b')] \right] \right\}. \quad (7)$$

In the above two equations,  $d_{-i}(b)$  is the compatibility choice of firm  $i$ 's rival in equilibrium (given the installed bases),  $p_{-i}(b, d)$  is the price charged by firm  $i$ 's rival in equilibrium (given the installed bases and the compatibility choices), the (constant) marginal cost of production is

normalized to zero, and  $\beta \in [0, 1)$  is the discount factor.

Eq. (6) is firm  $i$ 's Bellman equation, where  $V_i(b)$  is firm  $i$ 's value function and denotes the expected net present value of current and future profits of firm  $i$  in state  $b$  *before* the compatibility decisions have been made. In comparison,  $U_i(b, d)$ , defined in Eq. (7), denotes the expected net present value of current and future profits of firm  $i$  in state  $b$  *after* the compatibility decisions have been made and revealed to both firms. Note that  $V_i(\cdot)$  appears on the right-hand side of Eq. (7), and therefore enters into the right-hand side of Eq. (6) through  $U_i(\cdot)$ . Hence Eq. (6), the Bellman equation, provides a recursive definition of the value function  $V_i(\cdot)$ .

The max operator in Eq. (6) corresponds to firm  $i$ 's first-stage decision, in which it decides whether or not to propose compatibility, conditional on the state. The max operator in Eq. (7) corresponds to firm  $i$ 's second-stage decision, in which it chooses a price to maximize its expected payoff, conditional on the state and the two firms' first-stage compatibility decisions.

To understand Eq. (7), note that the term  $\bar{V}_{ij}(b) \equiv \sum_{b' \in \Omega} [\Pr(b'|b, q_j = 1)V_i(b')]$ , which appears at the end of the right-hand side of Eq. (7), is the expected continuation value to firm  $i$  conditional on firm  $j$  winning the purchase-decision-making consumer in the current period, where the expectation is taken over the probability distribution of the next-period state  $b'$  given the current-period state  $b$  and the assumption that firm  $j$  wins the purchase-decision-making consumer in the current period (i.e.,  $q_j = 1$ ). We then obtain the expected continuation value to firm  $i$  as the weighted average of the term  $\sum_{b' \in \Omega} [\Pr(b'|b, q_j = 1)V_i(b')]$ , where the weights are the consumer's choice probabilities  $\phi_{rj}(\cdot)$ ,  $j = 0, 1, 2$  (note that the choice probabilities sum to 1). Overall, on the right-hand side of Eq. (7), firm  $i$  chooses a price to maximize its expected payoff conditional on the state and the compatibility decisions, where the expectation is taken successively over (1) the probability distribution of the next-period state  $b'$ , (2) the consumer's choice probabilities, and (3) the probability distribution of  $r$  given the state  $b$ .

**First-Order Conditions for the Prices.** Let  $\bar{V}_{ij}(b)$  denote  $\sum_{b' \in \Omega} [\Pr(b'|b, q_j = 1)V_i(b')]$ . Differentiating the objective function in the maximization problem in Eq. (7) with respect to  $p_i$  and using the properties of logit demand (see Train (2009, p. 58)) yields the first-order condition<sup>7</sup>

$$E_{r|b} \left[ -\phi_{ri}(1 - \phi_{ri})(p_i + \beta \bar{V}_{ii}) + \phi_{ri} + \beta \phi_{ri} \sum_{j \neq i} (\phi_{rj} \bar{V}_{ij}) \right] = 0, \quad (8)$$

where  $\phi_{ri}$ ,  $\phi_{rj}$ ,  $\bar{V}_{ii}$ , and  $\bar{V}_{ij}$  are shorthand for  $\phi_{ri}(b, d, p_i, p_{-i}(b, d))$ ,  $\phi_{rj}(b, d, p_i, p_{-i}(b, d))$ ,  $\bar{V}_{ii}(b)$ , and  $\bar{V}_{ij}(b)$ , respectively, to simplify the notation. The pricing strategies  $p(b, d)$  are then the solution

<sup>7</sup>See Online Appendix 1 for the derivation of the first-order condition.

to the system of first-order conditions.

## 2.5 Equilibrium

I focus attention on symmetric Markov perfect equilibria (MPE), where symmetry means agents with identical states are required to behave identically.<sup>8</sup> Following the literature on numerically solving dynamic stochastic games (Pakes and McGuire (1994), Pakes and McGuire (2001)), I restrict attention to pure strategies. A symmetric MPE in pure strategies exists, which follows from the existence proof in Doraszelski and Satterthwaite (2010). Online Appendix 2 provides a description of the software and code used in computing the equilibrium in this paper.

## 2.6 Parameterization

The key parameters of the model are the quality of the outside good  $v_0$ , the rate of depreciation  $\delta$ , the strength of network effect  $\theta$ , and the switching cost  $k$ . I consider  $v_0 \in \{-5, -4, -3\}$  and use  $v_0 = -4$  as the baseline, which represents a case in which there exists an outside good but it is inferior compared to the inside goods, so that most but not all of the market is covered by the firms (a reasonable approximation of real-world examples such as the mobile phone industry and the banking industry). The lower bound for  $\delta$  is zero and corresponds to the unrealistic case in which installed bases never depreciate. On the other hand, if  $\delta$  is sufficiently high then the industry never takes off. I consider  $\delta \in \{0.05, 0.06, 0.07, 0.08\}$  and use  $\delta = 0.06$  as the baseline. I consider the following values for the strength of network effect and the switching cost:  $\theta \in \{1, 1.5, \dots, 4\}$ , and  $k \in \{0, 0.5, \dots, 3\}$ . The remaining parameters are held constant at  $M = 20$  and  $\beta = \frac{1}{1.05}$ , the latter of which corresponds to a yearly interest rate of 5%.

While the model is not intended to fit any specific industry, the own-price elasticities for the parameterizations that I consider are reasonable compared to the findings in several empirical studies. Specifically, the own-price elasticities for the baseline parameterizations range from  $-1.08$  to  $-0.48$ . These numbers are in line with the own-price elasticities reported in Gandalf, Kende, and Rob (2000) ( $-0.54$  for CD players, computed from the results reported in the paper), Clements and Ohashi (2005) (ranging from  $-2.15$  to  $-0.18$  for video game consoles), and Dick (2008) (ranging from  $-0.87$  to  $-0.12$  for banking services). Additionally, the aggregate market shares of the inside goods for the baseline parameterizations range from 86.9% to 99.3%. These numbers are consistent with, for instance, the cellular mobile penetration rates in OECD countries, which averaged at 96.1% in 2007 (OECD (2009)).

---

<sup>8</sup>With two firms, symmetry means firm 2's choices in state  $(b_1, b_2) = (\hat{b}, \tilde{b})$  are identical to firm 1's choices in state  $(b_1, b_2) = (\tilde{b}, \hat{b})$ .

### 3 Types of Equilibria

In this model three types of equilibria emerge: Rising, Tipping, and Compatibility.

#### 3.1 Rising Equilibrium

A *Rising* equilibrium (depicted in Figure 1) occurs when both network effect and switching cost are weak. A firm's price rises in its own installed base and falls in its rival's installed base (see Panel 1, which plots firm 1's equilibrium price against the firms' installed bases). Products are generally incompatible, except possibly when the firms have identical installed bases (see Panel 2, which reports the compatibility region; an asterisk indicates a state in which both firms prefer compatibility and thus products are compatible).

Panels 3 and 4 show the evolution of the industry structure over time. They plot the 15-period transient distribution of installed bases (which gives the frequency with which the industry state takes a particular value after 15 periods, starting from state  $(0,0)$  in period 0) and the limiting distribution (which gives the probability distribution of the state as the number of periods approaches infinity), respectively. The unimodal transient distribution and limiting distribution show that the market is generally fragmented, as the industry spends most of the time in fairly symmetric states.

Panel 5 plots the probability that a firm makes a sale, and Panel 6 plots the resultant forces, which report the expected movement of the state from one period to the next (for visibility of the arrows, the lengths of all arrows are normalized to 1, therefore only the direction, not the magnitude, of the expected movement is reported). The larger firm wins the consumer with a higher probability (Panel 5). However, the larger firm's expected size of depreciation is also larger. In a Rising equilibrium, the difference in expected depreciation more than offsets the difference in expected sales, and as a result the difference in installed bases shrinks in expectation (Panel 6).

When the market has considerable network effect and/or switching cost, two types of equilibria occur: Tipping equilibrium and Compatibility equilibrium. They are the focus of our attention, and are discussed below.

#### 3.2 Tipping Equilibrium

A *Tipping* equilibrium (depicted in Figure 2) occurs when the network effect is strong and the switching cost is modest. There is a deep trench along and around the diagonal of the price function (Panel 1), indicating intense price competition when firms' installed bases are of comparable size. Once a firm pulls ahead, the smaller firm stops competing for market dominance and raises its price,

thereby propelling the larger firm into a dominant position. In a Tipping equilibrium, products are almost always incompatible (in Panel 2, the products are incompatible except in two symmetric states).

The presence of strong network effects, which give the larger firm a significant quality advantage given that products are mostly incompatible, is the reason the smaller firm stops pricing aggressively once its rival pulls ahead. If instead it were to price aggressively and try to become the dominant firm, it would need to price at a substantial discount and such low pricing would have to continue for a long period of time in order to eliminate the installed base differential. Since such an aggressive strategy is not profitable, the smaller firm optimally chooses to raise its price and accept having a low market share.<sup>9</sup>

The transient distribution (Panel 3) and the limiting distribution (Panel 4) are bimodal. Over time, the industry moves towards asymmetric states, and the market tends to be dominated by a single firm.<sup>10</sup> The larger firm enjoys a significant advantage in expected sales (Panel 5), which results from the smaller firm's willingness to surrender (by not pricing aggressively), and gives rise to the forces that pull the industry away from the diagonal once an asymmetry arises (Panel 6).

### 3.3 Compatibility Equilibrium

A *Compatibility* equilibrium (depicted in Figure 3) occurs when the switching cost is strong. Products are compatible when firms have comparable installed bases (Panel 2). In the compatibility region, prices are high, peaking at the point where each firm has half of the consumers (Panel 1). Off of the peak, the smaller firm drops its price in order to bring the industry back to the peak. In particular, around the border of the compatibility region, the smaller firm lowers its price significantly, in an effort to keep the industry in the compatibility region. Away from the peak, the larger firm also drops its price, but that's a response to the smaller firm's aggressive pricing rather than an effort to achieve market dominance.

The switching cost segments the market into submarkets, with each submarket consisting of consumers that are locked-in by a firm. Firms focus on charging high prices to "harvest" their locked-in consumers, rather than competing fiercely for market dominance. As a result, the market

---

<sup>9</sup>Given the stochastic nature of the game, tipping can be reversed over time, though with small probabilities. Consider a market that has tipped in favor of firm 2. Although firm 1 is the smaller firm, it still has a positive probability of making a sale, albeit much smaller than firm 2's probability of making a sale (for example, in Panel 5 of Figure 2, the smaller firm makes a sale with a probability of about 20%, whereas the larger firm makes a sale with a probability of about 80%.) Consequently, given the randomness, with a small but positive probability, the smaller firm can be successful in making a sale several periods in a row, thereby reversing the market tipping.

<sup>10</sup>A Tipping equilibrium does not mean zero market share for the smaller firm. Instead, it means a rather asymmetric division of the market share between the two firms, with the larger firm occupying the majority of the market, leaving a very small share for the smaller firm.

tends to be fragmented, as shown by the unimodal transient distribution and limiting distribution in Panels 3 and 4, respectively.

The resultant forces (Panel 6) show global convergence towards the symmetric modal state. Outside the compatibility region, the larger firm enjoys a larger expected sale, but inside the compatibility region, the smaller firm has an advantage (Panel 5). Such an advantage for the smaller firm results from its aggressive pricing away from the peak, aimed at keeping the industry in the compatibility region.

### 3.4 Comparing Tipping and Compatibility Equilibria: Evolution of the Market

The infinite-horizon dynamic model in this paper allows us to gain more insights into the evolution of the market over time and better understand the contrast between the Tipping equilibrium and the Compatibility equilibrium.

Figure 4 plots the evolution of the market over time, from period 0 to period 100, starting from state (0,0) in period 0. The left column of panels plot for a Tipping equilibrium (the one depicted in Figure 2), and the right column of panels plot for a Compatibility equilibrium (the one depicted in Figure 3). From top to bottom, the four rows of panels plot the evolution of the installed bases, the probability of compatible networks, the prices, and the two firms' probabilities of sale, respectively. The solid lines show the expectation (based on the transient distributions) of the variables for the larger firm, and the dashed lines show those for the smaller firm. For the purpose of comparison, the scale and location of the  $y$ -axis are the same for panels in the same row.

First consider the firms' installed bases. In the Tipping equilibrium (Panel 1), the difference between the two firms' installed bases widens over time, and in the long run, the larger firm has an installed base more than twice as large as the smaller firm. In comparison, in the Compatibility equilibrium (Panel 2), the difference between the two firms' installed bases remains small throughout, and in the long run, there isn't a firm that vastly dominates the other.

Next consider the compatibility between the two networks. In the Tipping equilibrium (Panel 3), the probability of compatible networks is close to 0 throughout. In contrast, in the Compatibility equilibrium (Panel 4), after some initial fluctuations, the probability of compatible networks steadily increases to above 0.5, and stabilizes at 0.55 in the long run.

Next consider the firms' prices. In the Tipping equilibrium (Panel 5), the firms charge very low prices in the first few periods as they compete fiercely for an early advantage. After the first few periods, one of the firms has obtained an installed base advantage, and both firms increase their prices substantially. In the long run, the larger firm charges a higher price than the smaller firm, though not by much: the price stabilizes at 1.51 for the larger firm and 1.18 for the smaller firm.



In comparison, in the Compatibility equilibrium (Panel 6), the prices gradually increase over time, and in the long run the larger firm charges a price that is considerably higher than the smaller firm's: the long-run price is 3.05 for the larger firm and 1.98 for the smaller firm.

Lastly consider the firms' probabilities of sale. In the Tipping equilibrium (Panel 7), throughout the evolution of the market the larger firm enjoys a substantial advantage in probability of sale. This persistent advantage results from the fact that the larger firm provides the consumers with a much larger network and yet charges a price that is not much higher than the smaller firm's. In contrast, in the Compatibility equilibrium (Panel 8), the two firms have similar probabilities of sale throughout the evolution of the market. The reason for this pattern is that the larger firm's network is not much larger than the smaller firm's and the two networks are often made compatible, and yet the larger firm's price is considerably higher than the smaller firm's.

The only difference between the two equilibria plotted in Figure 4 is in the switching cost:  $k = 0.5$  for the left column (Tipping equilibrium) and  $k = 2.5$  for the right column (Compatibility equilibrium). Therefore, the results presented in Figure 4 illustrate that an increase in the switching cost in network industries can drastically change the firms' behavior, from fierce competition and incompatible networks to mild competition and compatible networks, resulting in a very different path for the evolution of the market.

## 4 Switching Costs and Equilibrium Outcome

In this model, the magnitude of the switching cost has significant impact on the equilibrium outcome, including the type of the equilibrium, firms' compatibility choices, market concentration, and prices, as illustrated in Figure 5.

### 4.1 Type of Equilibrium and Network Compatibility

Panel 1 in Figure 5 shows the type of equilibrium that occurs for different combinations of  $\theta$  (strength of network effect) and  $k$  (switching cost). When the network effect is modest ( $\theta \leq 2$ ), the outcome is a Rising equilibrium at low switching cost and a Compatibility equilibrium at high switching cost. When there is strong network effect ( $\theta > 2$ ), the outcome is a Tipping equilibrium at modest switching cost but changes to a Compatibility equilibrium at high switching cost.

Panel 2 plots the probability with which the networks are made compatible (based on the limiting distribution). The panel shows that when the switching cost is low, the probability of compatible networks is small for modest network effect and essentially zero for strong network effect. However, in both cases, this probability increases significantly as the switching cost increases,

indicating that higher switching cost induces firms to make their networks compatible. For example, with  $\theta = 1.5$ , the probability of compatible networks is 0.09 when  $k = 0$  (Rising equilibrium), but increases to 0.80 when  $k = 3$  (Compatibility equilibrium). With  $\theta = 3$ , the probability of compatible networks is 0.01 when  $k = 0$  (Tipping equilibrium), but increases to 0.61 when  $k = 3$  (Compatibility equilibrium).

## 4.2 Intuition for the Above Results

In this model, the two main factors that determine the market outcome are network effects and switching costs. To better understand the above results, we now consider how those two factors affect the firms' incentives and consequently the type of equilibrium that occurs in the market.

**Network Effects Alone.** The main property of network effects is that they tend to give rise to a “winner-takes-most” market structure: with strong network effects, a firm that has an installed base advantage over its rival is able to attract an outsized fraction of new buyers and switchers, allowing it to get an even bigger installed base advantage. This “snowball” effect leads to market tipping and propels the larger firm to a dominant position.

Anticipating this winner-takes-most tendency in the market, the firms compete fiercely (by charging very low prices) when they have similar installed bases, because they know that an early size advantage can propel them to a dominant position and allow them to reap high profits in the future. Such incentives of the firms are what give rise to the Tipping equilibrium, where there is a deep trench along and around the diagonal in a firm's price policy function (Panel 1 of Figure 2). In such an equilibrium, since the larger firm strives to achieve and maintain market dominance, it refuses compatibility in order to maintain its advantage over the smaller firm.

The above discussion sheds light on the changes in the type of equilibrium as we move around in the parameter space. In Panel 1 of Figure 5, when switching costs are low ( $k \leq 1$ ), the equilibrium changes from Rising to Tipping when  $\theta$  exceeds 2. The intuition is that when  $\theta$  exceeds a certain threshold, network effects are strong enough to generate the “snowball” effect and market tipping, thereby changing the equilibrium from Rising to Tipping.

**Switching Costs Alone.** The main property of switching costs is that they heighten the switching barrier for locked-in consumers and thereby lower the intensity of competition between the two firms. When switching costs make it more difficult for locked-in consumers to switch, the firms shift their focus from competing for each other's consumers to harvesting their own locked-in consumers and attracting new consumers (who are not loyal to either firm and do not face switching costs). To do so, the firms (1) charge high prices, and (2) agree to make their networks compatible

in order to increase the value of their products relative to the outside good. Such incentives of the firms are what give rise to the Compatibility equilibrium, where firms charge high prices and often make their networks compatible. In Panel 1 of Figure 5, when network effects are low ( $\theta \leq 2$ ), the equilibrium changes from Rising to Compatibility when  $k$  exceeds 0.5 (for  $\theta \leq 1.5$ ) or 1 (for  $\theta = 2$ ).

**Both Network Effects and Switching Costs.** When both network effects and switching costs are strong, there is a tension between those two factors: while network effects tend to give rise to fierce competition and incompatible networks (Tipping equilibrium), switching costs tend to give rise to mild competition and compatible networks (Compatibility equilibrium). The type of equilibrium that occurs in the market is then determined by the relative strengths of those two factors. For example, in Panel 1 of Figure 5, if we hold  $k$  fixed at 1.5 and increase  $\theta$  from 2.5 to 3, then network effects come to dominate switching costs and the type of equilibrium changes from Compatibility to Tipping. In contrast, if we hold  $\theta$  fixed at 3 and increase  $k$  from 1.5 to 2, then switching costs come to dominate network effects and the type of equilibrium changes from Tipping to Compatibility.

### 4.3 Market Concentration and Price

As changes in the switching cost alter the type of the equilibrium in the market and the firms' compatibility choices, one consequence is that the level of market concentration is affected. Panel 3 in Figure 5 plots the expected long-run Herfindahl-Hirschman Index (HHI; based on installed bases and weighted by the probabilities in the limiting distribution). A higher HHI indicates a more concentrated market. When the network effect is modest ( $\theta \leq 2$ ), the HHI is low throughout. However, when there is strong network effect ( $\theta > 2$ ), the HHI starts with a high level at low switching cost but drops significantly at high switching cost. In this case, the market is dominated by a single firm at low switching cost (high market concentration in a Tipping equilibrium), but becomes fragmented at high switching cost (low market concentration in a Compatibility equilibrium).

Panel 4 plots the average price (weighted by the firms' expected sales and the probabilities in the limiting distribution). The panel shows that in general, an increase in the switching cost increases the average price.<sup>11</sup> For example, with  $\theta = 1.5$ , the average price is 1.52 when  $k = 0$  (Rising equilibrium), but increases to 2.64 when  $k = 3$  (Compatibility equilibrium). With  $\theta = 3$ , the average price is 1.35 when  $k = 0$  (Tipping equilibrium), but increases to 2.82 when  $k = 3$  (Compatibility equilibrium).

---

<sup>11</sup>An exception is that when both the network effect and the switching cost are modest, a small increase in the switching cost can result in a reduction in the average price. In Panel 4 of Figure 5, this occurs when  $\theta \leq 2$  and  $k$  is increased from 0 to 0.5. This pattern is consistent with the finding in recent literature that in non-network industries, small switching costs can lead to lower prices (see, for example, Cabral (2009)).

We next examine the policy and welfare implications of these changes brought about by switching costs.

## 5 Public Policies and Welfare

In this section we evaluate two public policies in network industries related to switching costs and compatibility. The first policy is a reduction in switching costs, such as the implementation of mobile number portability in the mobile phone industry and the implementation of account number portability in the banking industry.<sup>12</sup> The second policy is mandating compatibility between different networks, such as shared on-net calling discounts and shared ATM networks.

### 5.1 Switching Costs Reduction and Mandatory Compatibility

Figure 6 shows the results from an evaluation of the above two public policies. From left to right, the two columns of panels correspond to  $\theta = 2$  and 3, respectively. Each panel plots how an equilibrium outcome variable is affected when switching costs are varied between 0 and 3. From top to bottom, the five rows of panels pertain to network compatibility, average price, producer surplus (PS), consumer surplus (CS), and total surplus (TS), respectively. Here, compatibility refers to the probability that products are made compatible, PS is the expected industry profits per period, CS is the expected consumer surplus per period, and TS is the sum of PS and CS. All five measures are weighted averages using the probabilities in the limiting distribution as the weights. The precise definitions for PS and CS are given in Online Appendix 3.

In each panel in Figure 6, three compatibility regimes are considered. The first regime is *endogenous compatibility*. This is the *laissez faire* regime and corresponds to the model that we have been analyzing so far. The second regime is *mandatory compatibility*, in which firms optimize with respect to price only, while we impose the condition that networks are compatible. We also consider a third regime, *prohibited compatibility*, in which firms optimize with respect to price only, given that networks are incompatible. This regime is not a policy being considered by regulators, and is included in the analysis for comparison purposes only.

**Compatibility.** Consistent with our discussions in the previous section, the first row of panels in Figure 6 show that under the endogenous compatibility regime (the dash-dot line), as switching

<sup>12</sup>In this paper, switching costs  $k$  is a fixed parameter from the firms' point of view. However, from the policy point of view,  $k$  is a parameter in the market that can be changed by the regulator. The analysis of a switching costs reduction policy is therefore a comparative statics analysis, i.e., the comparison of different economic outcomes before and after a change in an underlying exogenous parameter (in this case, the exogenous parameter that is being changed is  $k$ ).

costs are reduced from 3 to 0, firms become less likely to make their networks compatible, bringing the industry farther away from the mandatory compatibility regime (the solid line) and closer to the prohibited compatibility regime (the dotted line).

**Price and Producer Surplus.** Rows 2 and 3 show that reducing switching costs lowers average price and PS (except when switching costs are small, specifically when  $k \leq 0.5$ ) under each of the three compatibility regimes.<sup>13</sup> This is consistent with the intuition that as it becomes easier for consumers to switch, firms focus more on competing for each other’s customers and less on exploiting their locked-in customers. This results in a higher intensity of price competition, which lowers the firms’ profits.

**Consumer Surplus and Total Surplus.** We now examine the effect of a reduction in switching costs on CS and TS.

First consider CS. Panels 7 and 8 of Figure 6 show that compared to endogenous compatibility, mandatory compatibility raises CS, despite raising prices (as shown in Panels 3 and 4).

Under either mandatory compatibility or prohibited compatibility, the probability of compatible networks is fixed (at either 1 or 0). In both cases, a reduction in switching costs unambiguously increases CS, as shown in Panels 7 and 8.

However, under endogenous compatibility, which allows network compatibility to endogenously change as we vary switching costs, the effect of a reduction in switching costs on CS becomes ambiguous. That’s because the change in CS is now the result of two concurrent changes: the reduction in switching costs, and the consequent reduction in the probability of compatible networks. While the former tends to increase CS, the latter tends to reduce it.

Take Panel 8 ( $\theta = 3$ ) for example. As switching costs are reduced from 3 to 0, CS increases from 17.7 to 23.3 under mandatory compatibility, and from 2.3 to 9.3 under prohibited compatibility. Notice that CS is noticeably higher under mandatory compatibility than under prohibited compatibility: everything else equal, making the networks compatible generates larger benefits from network effects, thereby increasing CS.

In comparison, under endogenous compatibility, reducing switching costs from 3 to 0 lowers network compatibility significantly (from 0.61 to 0.01; see Panel 2). Correspondingly, when switching costs are reduced from 3 to 0, CS moves farther away from the CS under mandatory compatibility

---

<sup>13</sup>In Figure 6, the panels depicting average price (second row) and the ones depicting PS (third row) look similar to each other, and here’s the reason. In this paper the analysis focuses on industries in which there exists an outside good but it is inferior compared to the inside goods ( $v_0 = -4$  in the baseline, compared to  $v = 0$ ), so that most, but not all, of the market is covered by the firms, such as mobile phone services and banking services. Therefore, the industry profits, which equal the sum of the firms’ sales times average price-cost margin, are close to the average price, because the sum of the firms’ expected sales is close to 1 (due to the inferiority of the outside good) and the marginal cost is normalized to 0.

(which is higher) and closer to the CS under prohibited compatibility (which is lower), *dropping* from 11.7 to 9.5 in the process.

However, if the reduction in switching costs from 3 to 0 is combined with a mandatory compatibility policy, then CS increases significantly, from 11.7 ( $k = 3$  under endogenous compatibility) to 23.3 ( $k = 0$  under mandatory compatibility). The reason is that such a combination of policies allows consumers to benefit from both a reduction in switching costs and an increase in network compatibility.

Next consider TS. When switching costs are changed, the variation in PS is much smaller than the variation in CS (compare Panels 5 and 6 to Panels 7 and 8), so changes in TS (the sum of PS and CS) are largely determined by changes in CS. Consequently, we observe similar patterns in TS to those in CS.

Take Panel 10 ( $\theta = 3$ ) for example. As switching costs are reduced from 3 to 0, TS increases from 20.8 to 25.3 under mandatory compatibility, and from 4.5 to 10.7 under prohibited compatibility. In contrast, under endogenous compatibility, when switching costs are reduced from 3 to 0, TS moves farther away from the TS under mandatory compatibility (which is higher) and closer to the TS under prohibited compatibility (which is lower), *dropping* from 14.4 to 10.8 in the process. However, if the reduction in switching costs from 3 to 0 is combined with a mandatory compatibility policy, then there are sizable efficiency gains: TS increases from 14.4 ( $k = 3$  under endogenous compatibility) to 25.3 ( $k = 0$  under mandatory compatibility).

The patterns described above are further confirmed by the results from a broader set of parameterizations. Details are contained in Online Appendix 4.

## 5.2 Policy Discussion

The policy implication of the results above is the following. In a network industry with high switching costs, a public policy that reduces switching costs, by itself, does not lead to a substantial increase in total surplus, as the efficiency gains from lowering switching costs are offset by the efficiency losses from firms reducing the compatibility between their networks. However, if the switching costs reduction policy is combined with a public policy that mandates compatibility between networks, then there can be sizable efficiency gains, as such a combination makes it possible to have the best of both worlds—low switching costs and compatible networks.

The above finding is a possibility result, that is, it shows that it's possible to improve the welfare gains from switching costs reduction by combining it with mandatory compatibility. The success of such a policy would depend on the details of the implementation, such as deciding which standard to adopt, which are by no means straightforward and would require additional careful analysis.

Regarding policy implementation, there are two different ways to achieve compatibility: compatibility by standard and compatibility by contract. For example, during the AOL-Time Warner merger case (2000), with respect to AOL’s Instant Messaging (IM) service which dominated the IM market at the time, the FCC required that AOL cannot offer advanced IM services until it either demonstrates that it is no longer dominant in IM, or demonstrates that it has implemented interoperability (compatibility) by either adopting a public standard of interoperability (“interoperability by standard”) or entering into interoperability contracts with rival IM providers (“interoperability by contract”) (Faulhaber (2004, p. 469)).

Therefore, if a regulator wants to make compatibility mandatory, it doesn’t have to impose a specific standard, and in fact doing so sometimes backfires. For example, in the 1950s, although the FCC mandated the CBS color TV standard, the market demanded NBC’s NTSC standard instead, and the FCC was forced to change its decision.<sup>14</sup> Instead, it may be better for the regulator to simply require that the firms either adopt a public standard (letting the firms or the market decide which standard to adopt) or enter into compatibility contracts between themselves.

Moreover, if compatibility is implemented by standard, it is likely that some R&D is required for changing a standard, and so the firms may not be able to change compatibility very frequently. Therefore, the assumption in this paper that in each period the firms can propose compatibility or incompatibility is a simplification and is more suitable for cases in which compatibility is implemented by contract, which doesn’t involve designing and adopting a new standard and *may* be easier to implement. Also, the difficulty with which compatibility can be changed likely varies across different industries and would need to be assessed on a case-by-case basis.

Finally, the model in this paper does not consider innovation, which can play an important role in determining the firms’ profits and the consumer welfare, and we should therefore take the above welfare findings with a grain of salt. While innovation is an important issue, given the several elements already in the model (network effects, switching costs, and compatibility choices), additionally incorporating innovation would make the model intractable (in that case, the two firms’ endogenous product qualities would also become state variables, resulting in a 4-dimensional state space and substantially increasing the difficulty of computation). I therefore consider innovation an interesting issue but out of the scope of this paper, and leave it for future research. Nonetheless, the analysis in this paper illustrates the potential efficiency gains that can be achieved by combining the two policies, and the welfare results here can serve as a benchmark for further analysis.

---

<sup>14</sup>I thank a referee for suggesting this example.

### 5.3 A More General Form of Network Effect

In the model of this paper, in a consumer's utility function, the term  $\theta g(b_i + d_1 d_2 b_{-i})$  describes the network benefit. If the two networks are made compatible (i.e.,  $d_1 d_2 = 1$ ), the consumer derives the same benefit from each of the networks. Here we consider a more general setting, in which the two networks may not bring the same benefit to the consumer. Specifically, let the consumer's utility from the network effect take the form  $\theta g(b_i + w d_1 d_2 b_{-i})$ , where  $w \in (0, 1]$  is the weight parameter.

The main specification analyzed in this paper, in which the consumer derives the same benefit from each network when the two networks are made compatible, corresponds to  $w = 1$  (full compatibility). In comparison, when  $w < 1$ , firm  $i$ 's consumer enjoys a smaller benefit from firm  $i$ 's competitor's network than from firm  $i$ 's network (partial compatibility). We consider the following values of  $w$  in this robustness check:  $w \in \{0.75, 0.5, 0.25\}$ .

The results from this robustness check are discussed in Online Appendix 5. They show that the main findings of the paper are robust to changing the value of  $w$ . For example, they show that changing the value of  $w$  has minimal effect on the type of equilibrium that occurs: for most of the parameterizations, the type of equilibrium remains unchanged as we change the value of  $w$ . For more results from and discussions of this robustness check please refer to Online Appendix 5.

## 6 Conclusion

In this paper, I investigate how switching costs affect product compatibility and market dynamics in network industries. Firms face a choice between two modes of competition: make their networks incompatible and compete fiercely for market dominance, or make their networks compatible and have mild competition. By incentivizing firms to harvest their locked-in consumers rather than price aggressively for market dominance, switching costs tip the balance in favor of compatible networks and mild competition.

Accordingly, public policies that reduce switching costs in network industries, such as mobile number portability and banking account number portability, can change the market outcome from compatible networks to incompatible networks. In the former, price competition is mild and the market is often fragmented, whereas in the latter, firms compete fiercely for market dominance and in the long run the market is dominated by one firm.

Consequently, in a network industry with high switching costs, a switching costs reduction policy alone would result in small efficiency gains at best, as the efficiency gains from lowering switching costs are offset by the efficiency losses from firms reducing the compatibility between their networks. However, if the switching costs reduction policy is combined with a public policy



that mandates compatibility between networks, then there can be sizable efficiency gains, as such a combination makes it possible to have the best of both worlds—low switching costs and compatible networks.

Lastly, I reiterate the caveat that I have had to make some simplifying assumptions (including myopic consumers and absence of innovation) in this paper to facilitate its computation, and therefore the results should be interpreted with some caution. Nevertheless, one general policy implication which arises from these results is the importance of properly accounting for firms' compatibility choices in analyses of network industries and switching costs. Regulations that directly or indirectly affect network compatibility can have profound and sometimes unexpected effects on competition and welfare. Thus the findings in this paper call for further research on the design and evaluation of public policies in network industries, paying particular attention to the interactions of the various features of the market.

## References

- ANDERSON, S. P., A. DE PALMA, AND J.-F. THISSE (1992): *Discrete Choice Theory of Product Differentiation*. The MIT Press.
- BEGGS, A., AND P. KLEMPERER (1992): "Multi-Period Competition with Switching Costs," *Econometrica*, 60(3), 651–666.
- BENKARD, C. L. (2004): "A Dynamic Analysis of the Market for Wide-Bodied Commercial Aircraft," *Review of Economic Studies*, 71, 581–611.
- BUSSE, M. R., C. R. KNITTEL, AND F. ZETTELMEYER (2013): "Are Consumers Myopic? Evidence from New and Used Car Purchases," *American Economic Review*, 103(1), 220–256.
- CABRAL, L. (2009): "Small Switching Costs Lead to Lower Prices," *Journal of Marketing Research*, 46, 449–451.
- (2011): "Dynamic Price Competition with Network Effects," *Review of Economic Studies*, 78, 83–111.
- CHEN, J. (2016): "How do Switching Costs Affect Market Concentration and Prices in Network Industries?," *Journal of Industrial Economics*, 64, 226–254.
- CHEN, J., U. DORASZELSKI, AND J. HARRINGTON (2009): "Avoiding Market Dominance: Product Compatibility in Markets with Network Effects," *RAND Journal of Economics*, 40(3), 455–485.

- CHEN, Y., AND R. ROSENTHAL (1996): “Dynamic duopoly with slowly changing customer loyalties,” *International Journal of Industrial Organization*, 14, 269–296.
- CHING, A. T. (2010): “A Dynamic Oligopoly Structural Model for the Prescription Drug Market After Patent Expiration,” *International Economic Review*, 51, 1175–1207.
- CLEMENTS, M., AND H. OHASHI (2005): “Indirect Network Effects and the Product Cycle: U.S. Video Games, 1994 - 2002,” *Journal of Industrial Economics*, 53, 515–542.
- CREMER, J., P. REY, AND J. TIROLE (2000): “Connectivity in the Commercial Internet,” *Journal of Industrial Economics*, 48, 433–472.
- DICK, A. A. (2008): “Demand estimation and consumer welfare in the banking industry,” *Journal of Banking & Finance*, 32, 1661–1676.
- DORASZELSKI, U., AND M. SATTERTHWAITTE (2010): “Computable Markov-Perfect Industry Dynamics,” *Rand Journal of Economics*, 41(2), 215–243.
- DRISKILL, R. (2007): “Monopoly and Oligopoly Supply of a Good with Dynamic Network Externalities,” Vanderbilt University.
- ECAFSS (2006): “Competition Issues In Retail Banking and Payments Systems Markets In The EU,” European Competition Authorities Financial Services Subgroup (Place Madou, Madouplein 1, 1210 Saint-Josse-ten-Noode, Belgium).
- ECONOMIDES, N., AND F. FLYER (1997): “Compatibility and Market Structure for Network Goods,” New York University.
- FARRELL, J., AND G. SALONER (1986): “Standardization and variety,” *Economics Letters*, 20(1), 71–74.
- FAULHABER, G. R. (2004): “Access and Network Effects in the “New Economy”: AOL-Time Warner (2000),” in *The Antitrust Revolution: Economics, Competition, and Policy*, ed. by J. E. Kwoka, and L. J. White, pp. 453–475. Oxford University Press, 4th edn.
- FERSHTMAN, C., AND A. PAKES (2000): “A Dynamic Oligopoly with Collusion and Price Wars,” *RAND Journal of Economics*, 31(2), 207–236.
- FILSON, D. (2012): “A Markov-perfect equilibrium model of the impacts of price controls on the performance of the pharmaceutical industry,” *RAND Journal of Economics*, 43, 110–138.

- GANDAL, N., M. KENDE, AND R. ROB (2000): “The Dynamics of Technological Adoption in Hardware/Software Systems: The Case of Compact Disc Players,” *Rand Journal of Economics*, 31, 43–61.
- GOWRISANKARAN, G., AND R. J. TOWN (1997): “Dynamic Equilibrium in the Hospital Industry,” *Journal of Economics & Management Strategy*, 6, 45–74.
- HANNAN, T. H. (2007): “ATM surcharge bans and bank market structure: The case of Iowa and its neighbors,” *Journal of Banking & Finance*, 31, 1061–1082.
- KATZ, M. L., AND C. SHAPIRO (1986): “Product Compatibility Choice in a Market with Technological Progress,” *Oxford Economic Papers*, 38, S146–S165.
- LAFFONT, J.-J., P. REY, AND J. TIROLE (1998): “Network Competition: II. Price Discrimination,” *RAND Journal of Economics*, 29(1), 38–56.
- LLOBET, G., AND M. MANOVE (2006): “Network Size and Network Capture,” CEMFI Working Paper No. 0604 (Calle Casado del Alisal, 5; 28014 Madrid, Spain).
- MALUEG, D. A., AND M. SCHWARTZ (2006): “Compatibility Incentives of a Large Network Facing Multiple Rivals,” *Journal of Industrial Economics*, 54, 527–567.
- MANENTI, F. M., AND E. SOMMA (2002): “One-Way Compatibility, Two-Way Compatibility and Entry in Network Industries,” Working Paper. Southern Europe Research in Economic Studies, Series n. 4.
- MARKOVICH, S. (2008): “Snowball: A Dynamic Oligopoly Model with Indirect Network Effects,” *Journal of Economic Dynamics & Control*, 32(3), 909–938.
- MIAO, C.-H. (2010): “Consumer myopia, standardization and aftermarket monopolization,” *European Economic Review*, 54, 931–946.
- MITCHELL, M. F., AND A. SKRZYPACZ (2006): “Network externalities and long-run market shares,” *Economic Theory*, 29, 621–648.
- OECD (2009): “OECD Communications Outlook 2009,” Organisation for Economic Co-operation and Development.
- PAKES, A., AND P. MCGUIRE (1994): “Computing Markov-Perfect Nash Equilibria: Numerical Implications of a Dynamic Differentiated Product Model,” *Rand Journal of Economics*, 25(4), 555–589.

- (2001): “Stochastic Algorithms, Symmetric Markov Perfect Equilibrium, and the ‘Curse’ of Dimensionality,” *Econometrica*, 69(5), 1261–1281.
- SHI, M., J. CHIANG, AND B.-D. RHEE (2006): “Price Competition with Reduced Consumer Switching Costs: The Case of “Wireless Number Portability” in the Cellular Phone Industry,” *Management Science*, 52, 27–38.
- SHY, O. (2001): *The Economics of Network Industries*. Cambridge University Press.
- TAN, W. (2006): “The Effects of Taxes and Advertising Restrictions on the Market Structure of the U.S. Cigarette Market,” *Review of Industrial Organization*, 28, 231–251.
- TAYLOR, C. (2003): “Supplier surfing: Competition and consumer behavior in subscription markets,” *RAND Journal of Economics*, 34, 223–246.
- TRAIN, K. E. (2009): *Discrete Choice Methods with Simulation*. Cambridge University Press, second edn.
- TRAN, D. V. (2006): “Network Externality, Minimal Compatibility, Coordination and Innovation,” University of Texas.
- ZUCCHINI, L., J. CLAUSSEN, AND M. TRG (2013): “Tariff-mediated network effects versus strategic discounting: Evidence from German mobile telecommunications,” *International Journal of Industrial Organization*, 31, 751–759.

(1) Firm 1's policy function

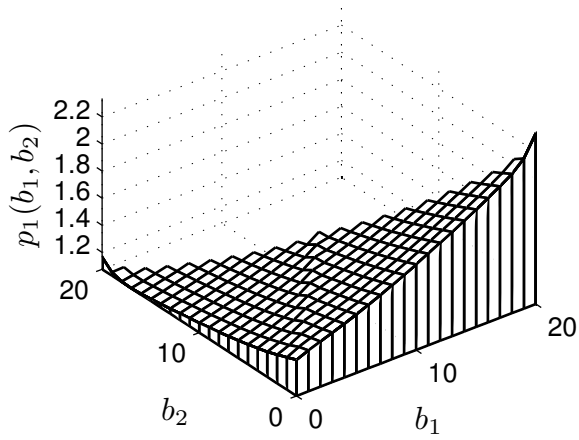

(2) Compatibility

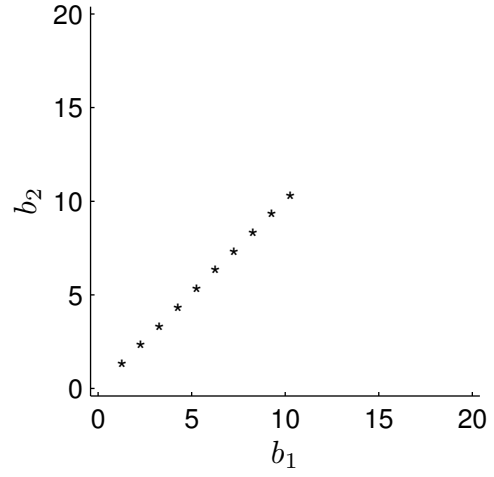

(3) Transient distribution after 15 periods

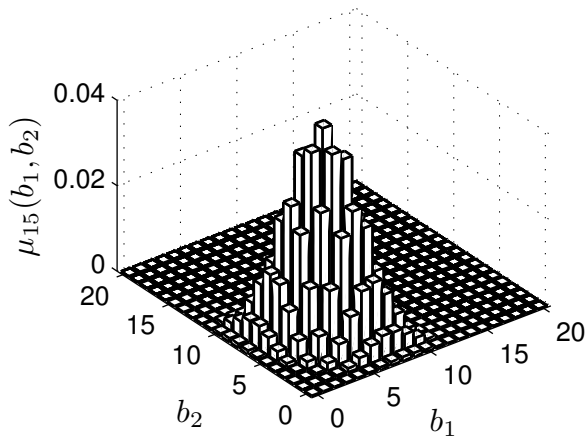

(4) Limiting distribution

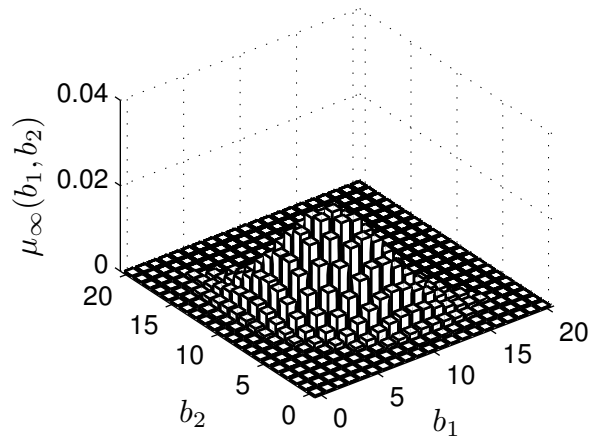

(5) Probability that firm 1 makes a sale

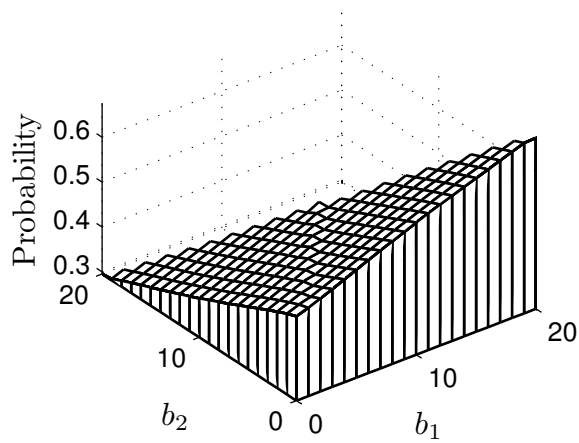

(6) Resultant forces

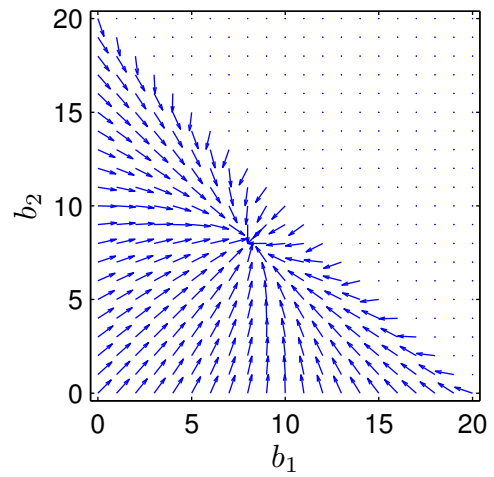
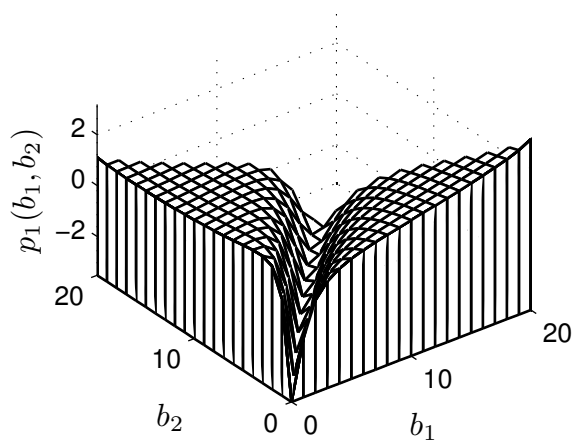
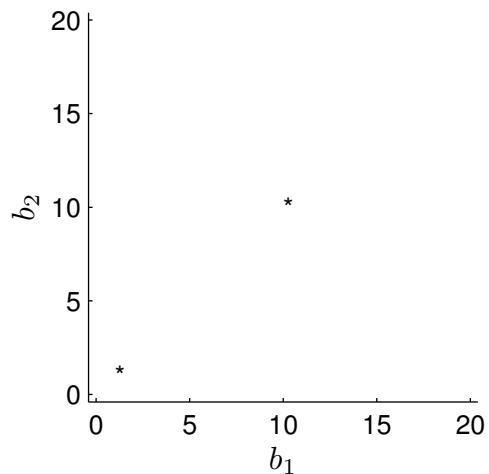

Figure 1. Rising equilibrium:  $v_0 = -4$ ,  $\delta = 0.06$ ,  $\theta = 1.5$ ,  $k = 0.5$

(1) Firm 1's policy function



(2) Compatibility



(3) Transient distribution after 15 periods

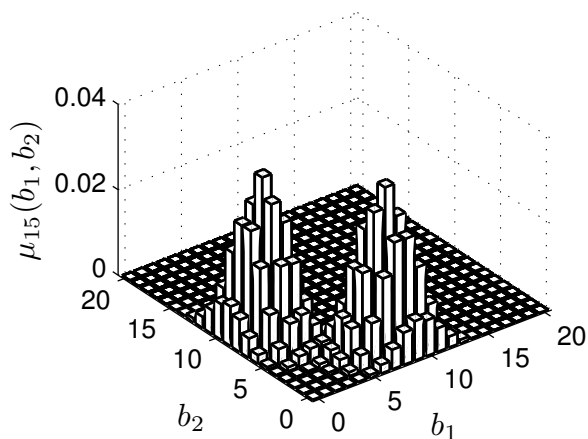

(4) Limiting distribution

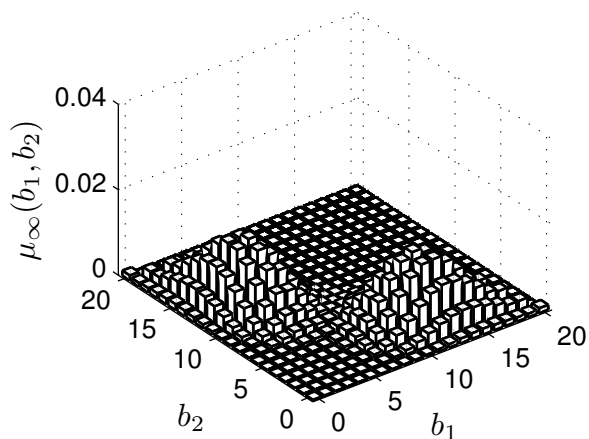

(5) Probability that firm 1 makes a sale

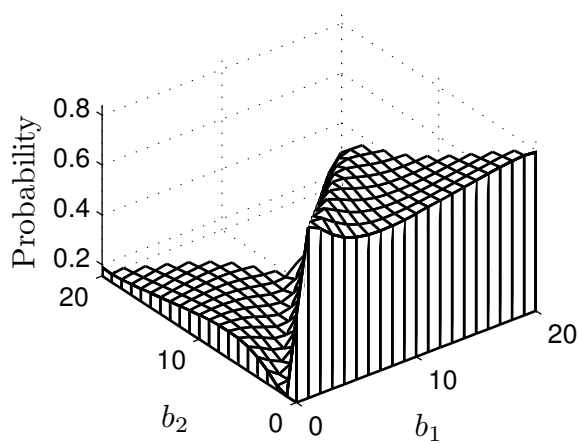

(6) Resultant forces

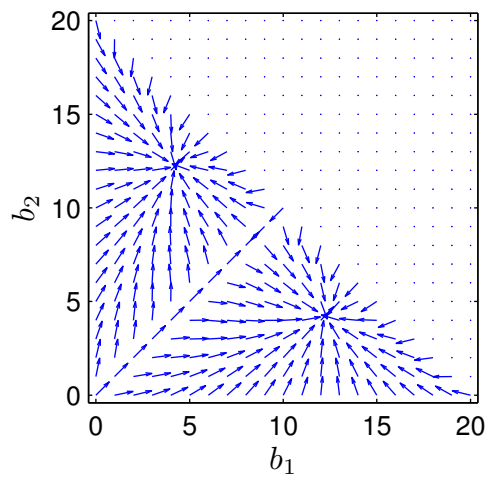
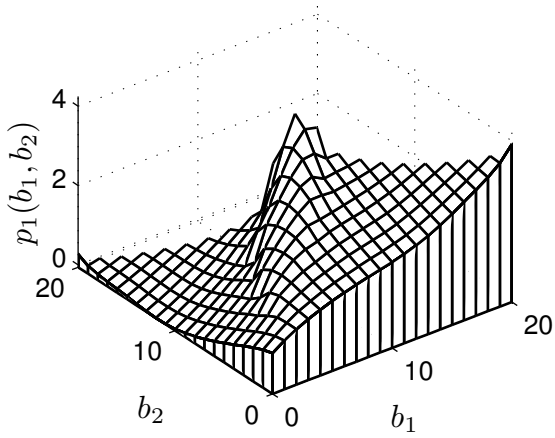
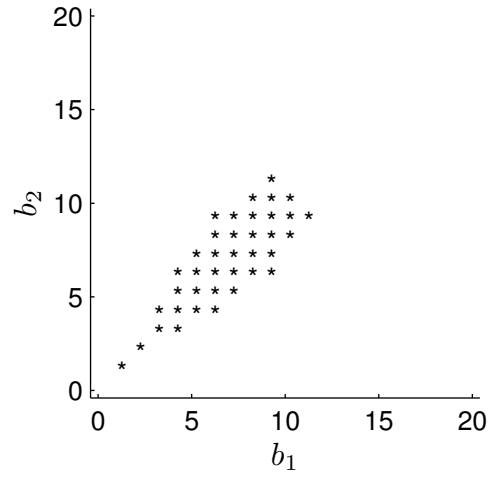

Figure 2. Tipping equilibrium:  $v_0 = -4$ ,  $\delta = 0.06$ ,  $\theta = 3$ ,  $k = 0.5$

(1) Firm 1's policy function



(2) Compatibility



(3) Transient distribution after 15 periods

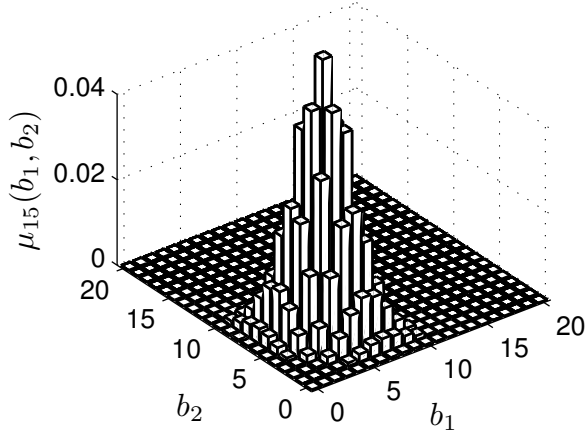

(4) Limiting distribution

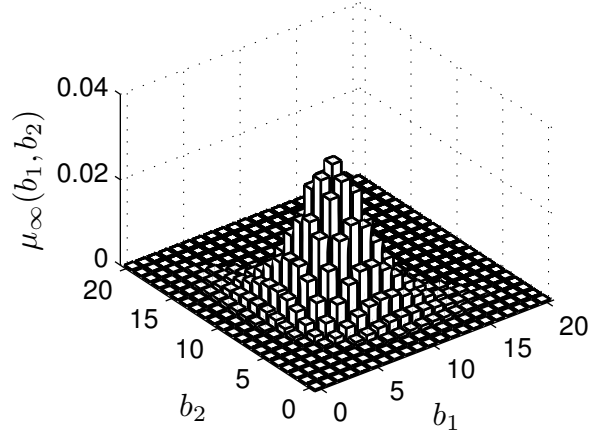

(5) Probability that firm 1 makes a sale

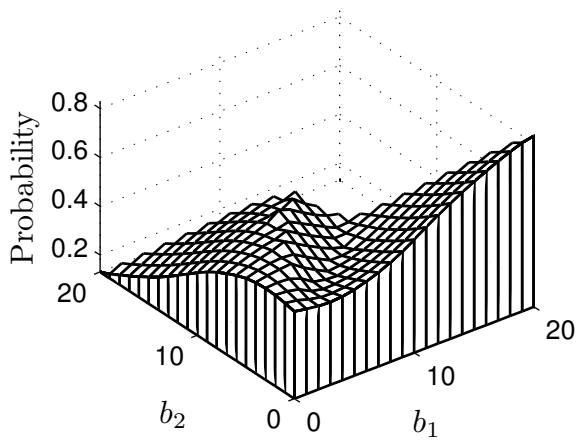

(6) Resultant forces

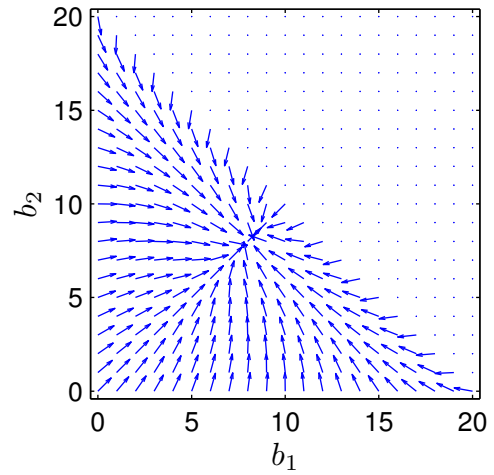

Figure 3. Compatibility equilibrium:  $v_0 = -4$ ,  $\delta = 0.06$ ,  $\theta = 3$ ,  $k = 2.5$

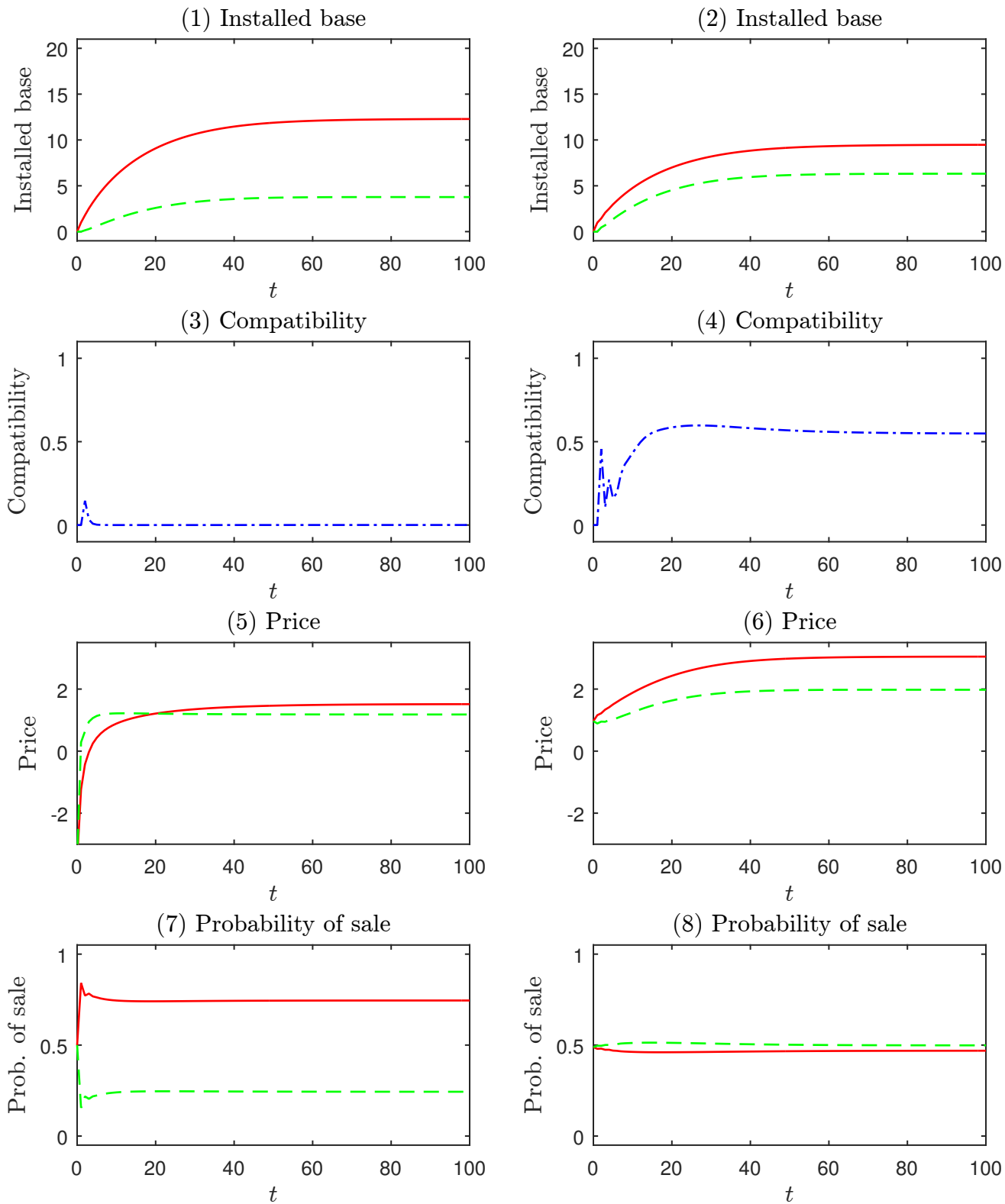
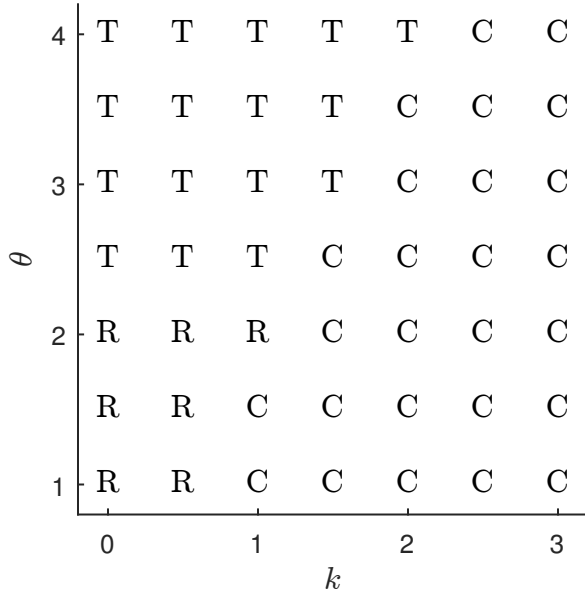

Figure 4. Comparing Tipping equilibrium and Compatibility equilibrium: evolution of market. Left column: Tipping equilibrium. Right column: Compatibility equilibrium. Solid line: the larger firm. Dashed line: the smaller firm. Dash-dot line: not firm-specific.



(1) Type of equilibrium (R = Rising, T = Tipping, C = Compatibility)



(2) Probability of compatible networks

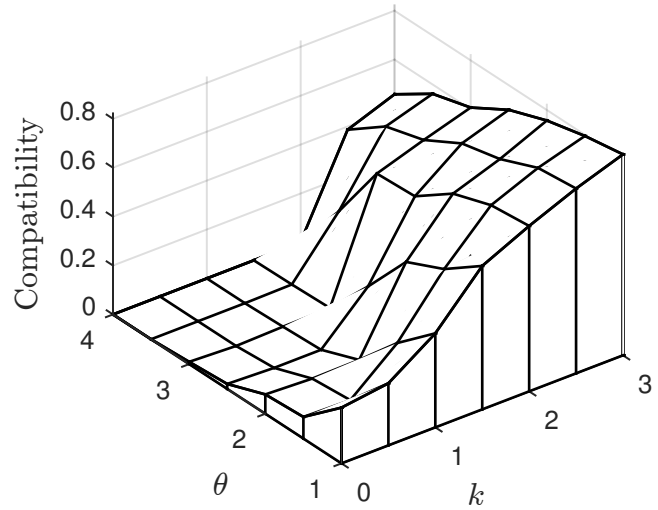

(3) Market concentration

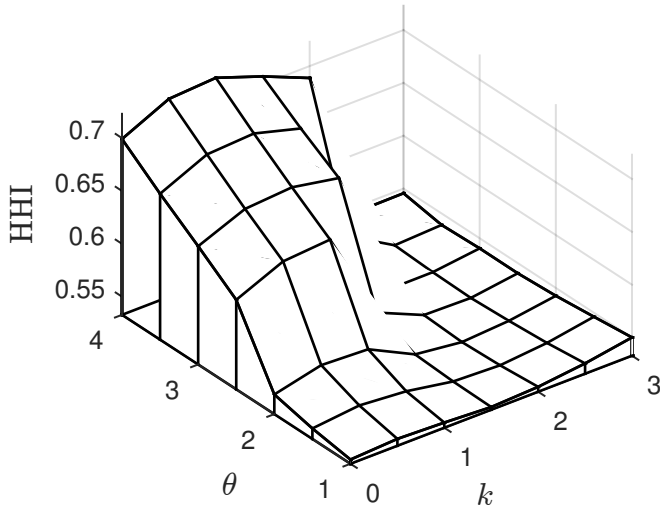

(4) Average price

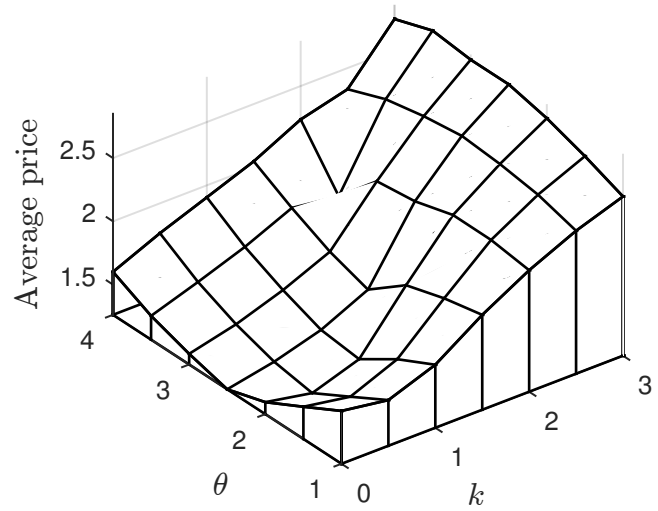

Figure 5. Switching costs and equilibrium outcome.  $v_0 = -4$ ,  $\delta = 0.06$ .

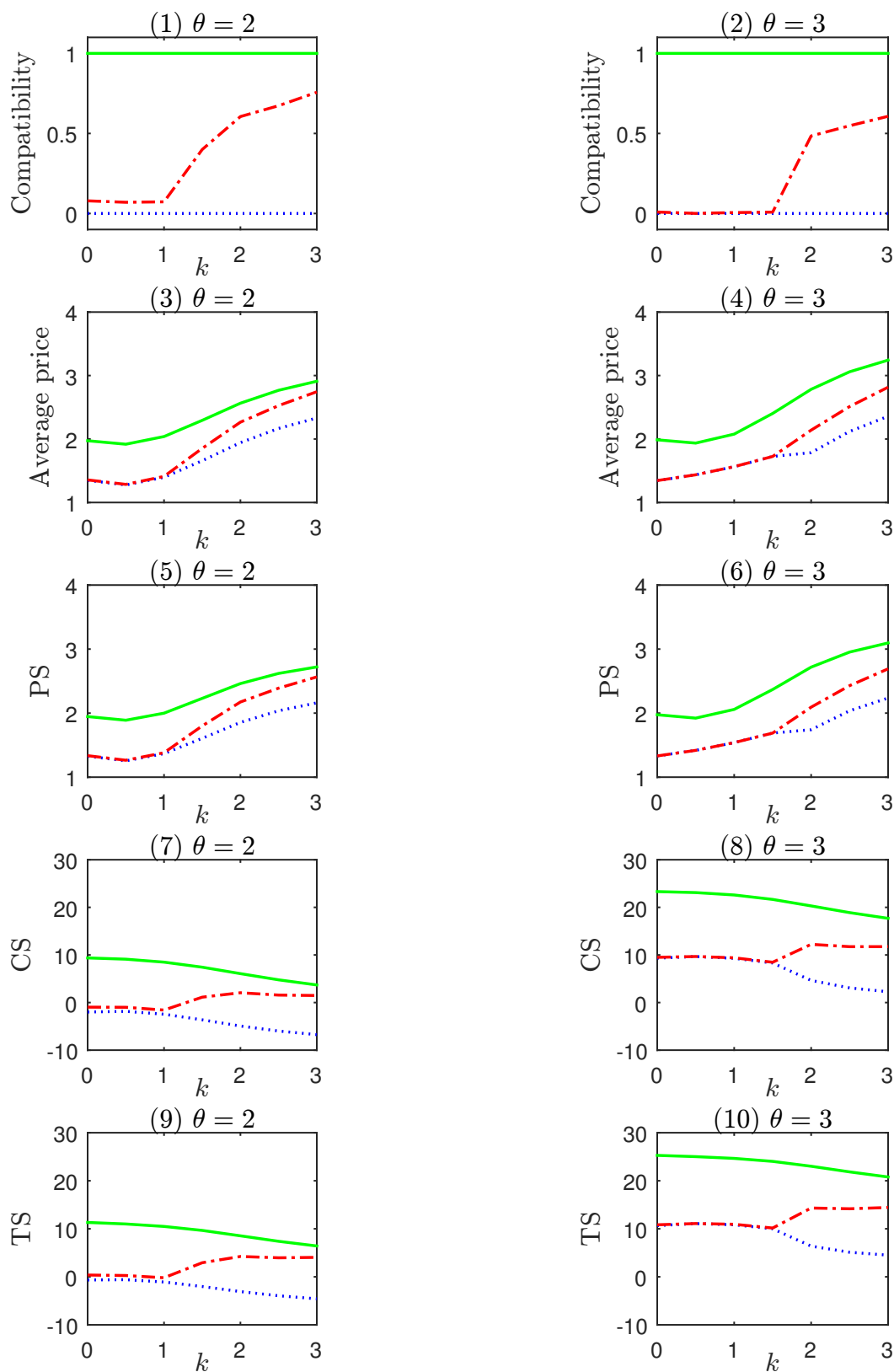

Figure 6. Switching costs, compatibility, and welfare.  $v_0 = -4$ ,  $\delta = 0.06$ .

Solid lines: mandatory compatibility (MC). Dash-dot lines: endogenous compatibility (EC). Dotted lines: prohibited compatibility (PC).

# Online Appendix

## 1 Deriving the First-Order Condition

Let  $\psi_i(p_i; b, d)$  denote the objective function in the maximization problem in Eq. (7):

$$\psi_i(p_i; b, d) \equiv E_{r|b} \left\{ \phi_{ri}(b, d, p_i, p_{-i}(b, d))p_i + \beta \sum_{j=0}^2 \left[ \phi_{rj}(b, d, p_i, p_{-i}(b, d)) \sum_{b' \in \Omega} [\Pr(b'|b, q_j = 1)V_i(b')] \right] \right\}.$$

Let  $\bar{V}_{ij}(b)$  denote  $\sum_{b' \in \Omega} [\Pr(b'|b, q_j = 1)V_i(b')]$ . Below we derive the first-order condition. First,

$$\frac{\partial \psi_i(p_i; b, d)}{\partial p_i} = 0 \Leftrightarrow E_{r|b} \left[ \frac{\partial \phi_{ri}}{\partial p_i} p_i + \phi_{ri} + \beta \sum_{j=0}^2 \left( \frac{\partial \phi_{rj}}{\partial p_i} \bar{V}_{ij} \right) \right] = 0,$$

where  $\phi_{ri}$ ,  $\phi_{rj}$ , and  $\bar{V}_{ij}$  are shorthand for  $\phi_{ri}(b, d, p_i, p_{-i}(b, d))$ ,  $\phi_{rj}(b, d, p_i, p_{-i}(b, d))$ , and  $\bar{V}_{ij}(b)$ , respectively, to simplify the notation.

Using the properties of logit demand regarding derivatives of the choice probabilities (see Train (2009, p. 58)),

$$\begin{aligned} \frac{\partial \phi_{ri}}{\partial p_i} &= \frac{\partial \bar{u}_{ri}}{\partial p_i} \phi_{ri}(1 - \phi_{ri}) = -\phi_{ri}(1 - \phi_{ri}), \text{ and} \\ \frac{\partial \phi_{rj}}{\partial p_i} &= -\frac{\partial \bar{u}_{ri}}{\partial p_i} \phi_{ri} \phi_{rj} = \phi_{ri} \phi_{rj}, \text{ for } j \neq i, \end{aligned}$$

where  $\bar{u}_{ri}$  is the deterministic part in  $u_{ri}(\cdot)$  (see Eq. (1) in the paper):

$$\bar{u}_{ri} \equiv u_{ri} - \epsilon_i = v_i + \mathbf{1}(i \neq 0)\theta g(b_i + d_1 d_2 b_{-i}) - p_i - \mathbf{1}(r \neq 0 \text{ and } i \neq 0 \text{ and } i \neq r)k.$$

Therefore,

$$\begin{aligned} \frac{\partial \psi_i(p_i; b, d)}{\partial p_i} = 0 &\Leftrightarrow E_{r|b} \left[ -\phi_{ri}(1 - \phi_{ri})p_i + \phi_{ri} + \beta [-\phi_{ri}(1 - \phi_{ri})] \bar{V}_{ii} + \beta \sum_{j \neq i} (\phi_{ri} \phi_{rj} \bar{V}_{ij}) \right] = 0 \\ &\Leftrightarrow E_{r|b} \left[ -\phi_{ri}(1 - \phi_{ri})(p_i + \beta \bar{V}_{ii}) + \phi_{ri} + \beta \phi_{ri} \sum_{j \neq i} (\phi_{rj} \bar{V}_{ij}) \right] = 0. \end{aligned}$$

## 2 Description of Software and Code Used in Computation

The computation in this paper is carried out using MATLAB, a programming language developed by MathWorks intended primarily for numerical computing.

The computation code uses an iterative algorithm to solve for a firm's equilibrium value function and policy functions. The algorithm follows Chen, Doraszelski, and Harrington (2009). It takes a value function  $\tilde{V}_i(b)$  for each firm  $i$  as the starting point for an iteration and generates an updated value function  $V_i(b)$  along with policy functions  $p_i(b, d)$  and  $d_i(b)$ . The initial value is  $\tilde{V}_i(b) = 0$ ,  $i = 1, 2$  and for all  $b$ .

Each iteration cycles through the state space in some predetermined order. Given a state  $b$ , it solves for the subgame-perfect Nash equilibrium of the two-stage game in that state, holding fixed the continuation values. Specifically, in each iteration the algorithm proceeds as follows.

First, solve the system of first-order conditions (8) given first  $d_1(b) = d_2(b) = 0$  and then  $d_1(b) = d_2(b) = 1$ . This yields prices given compatibility decisions, i.e.,  $p_i(b, (0, 0))$  and  $p_i(b, (1, 1))$ ,  $i = 1, 2$ .

Second, substitute the price policy functions  $p_i(b, (0, 0))$  and  $p_i(b, (1, 1))$ ,  $i = 1, 2$  into the objective function in Eq. (7). This yields payoffs given compatibility decisions, i.e.,  $U_i(b, (0, 0))$  and  $U_i(b, (1, 1))$ ,  $i = 1, 2$ .

Third, determine the firms' compatibility decisions as

$$d_i(b) = \begin{cases} 1 & \text{if } U_1(b, (1, 1)) > U_1(b, (0, 0)) \text{ and } U_2(b, (1, 1)) > U_2(b, (0, 0)), \\ 0 & \text{otherwise.} \end{cases}$$

Lastly, substitute the compatibility policy functions  $d_i(b)$ ,  $i = 1, 2$  into the objective function in Eq. (6) to obtain the value functions  $V_i(b)$  as  $U_i(b, (d_i(b), d_{-i}(b)))$ ,  $i = 1, 2$ .

Once the computation for one state is completed, the algorithm moves on to another state. After all states have been visited, the algorithm updates the current guess for the value function by setting  $\tilde{V}_i(b) = V_i(b)$ ,  $i = 1, 2$  and for all  $b$ . This completes the iteration. The algorithm continues to iterate until the relative change in the value and the policy functions from one iteration to the next is below a pre-specified tolerance.

### 3 Definitions of PS and CS

This appendix gives the definitions of producer surplus (PS) and consumer surplus (CS), discussed in Section 5 of the paper. PS is the expected industry profits per period, where the expectation is taken over the limiting distribution of the industry state and the probability distribution of the consumer's loyalty  $r$  given the industry state:

$$\text{PS} = \sum_{b \in \Omega} \left\{ \mu_\infty(b) \times E_{r|b} [\phi_{r1}(\cdot)p_1(b) + \phi_{r2}(\cdot)p_2(b)] \right\}. \quad (9)$$

Here  $\mu_\infty(b)$  is the probability given to state  $b$  in the limiting distribution (therefore  $\sum_{b \in \Omega} \mu_\infty(b) = 1$ ),  $\phi_{r1}(\cdot) = \phi_{r1}(b, d_1(b), d_2(b), p_1(b), p_2(b))$  and  $\phi_{r2}(\cdot) = \phi_{r2}(b, d_1(b), d_2(b), p_1(b), p_2(b))$  are the consumer's equilibrium choice probabilities for firms 1 and 2 in state  $b$ , respectively, and  $d_1(b)$ ,  $d_2(b)$ ,  $p_1(b)$ , and  $p_2(b)$  are the firms' equilibrium compatibility and price choices in state  $b$ , respectively. Since the (constant) marginal cost of production is normalized to zero,  $p_i(b)$  is firm  $i$ 's profit if it makes a sale.

Note that given the stationarity of the limiting distribution, in equilibrium the expected net present value (NPV) of the two firms combined can be obtained by scaling up the PS defined above:  $\sum_{b \in \Omega} \{ \mu_\infty(b) \times (V_1(b) + V_2(b)) \} = \text{PS} + \beta \text{PS} + \beta^2 \text{PS} + \dots = \text{PS} / (1 - \beta)$ .

CS is the expected consumer surplus per period:

$$\text{CS} = \sum_{b \in \Omega} \left\{ \mu_\infty(b) \times \left\{ E_{r|b} \left[ \ln \left( \sum_{i=0,1,2} \exp(\bar{u}_{ri}) \right) \right] + \sum_{i=0,1,2} (n_i \bar{w}_i) \right\} \right\}. \quad (10)$$

Here  $\bar{u}_{ri} \equiv u_{ri}(b, d_1(b), d_2(b), p_1(b), p_2(b)) - \epsilon_i$  is the deterministic part in  $u_{ri}(\cdot)$  (see Eq. (1) in the paper),  $n_i$  is the expected number of consumers who keep their existing product  $i$  in the current

period, and  $\bar{w}_i \equiv w_i(b, d_1(b), d_2(b)) - \epsilon_i$  is the deterministic part in  $w_i(\cdot)$  (see Eq. (2) in the paper). Below I explain this formula for CS.

In any given state  $b$ , the consumers can be divided into four groups for the purpose of computing consumer surplus. First, there is one consumer who makes a purchasing decision. This consumer pays for the product that she chooses, and may incur switching costs depending on her choice. Assuming that she is loyal to product  $r$ , given the *i.i.d.* type I extreme value assumption on the  $\epsilon_i$ 's, her expected consumer surplus is the so called "log-sum term",  $\ln \left( \sum_{i=0,1,2} \exp(\bar{u}_{ri}) \right)$  (see Train (2009, p. 55)). Since  $r$  is stochastic, we take the expectation of this log-sum term over the distribution of  $r$  given  $b$ , and obtain  $E_{r|b} \left[ \ln \left( \sum_{i=0,1,2} \exp(\bar{u}_{ri}) \right) \right]$  as this consumer's expected surplus.

The other three groups of consumers are those who keep their existing product  $i$  in the current period,  $i = 0, 1, 2$ , respectively. These consumers do not pay a price, and do not incur switching costs. Given the depreciation process specified in Subsection 2.3 of the paper, the expected number of each of these groups of consumers is:  $n_1 = (1 - \delta)b_1$ ,  $n_2 = (1 - \delta)b_2$ , and  $n_0 = M - n_1 - n_2 - 1$ .<sup>15</sup> Furthermore, given the assumption that the  $\epsilon$ 's have zero mean, when computing the expected consumer surplus for these consumers, we can ignore the  $\epsilon$ 's, and obtain the expected consumer surplus for each one of them as  $\bar{w}_i$ .

Finally, the expression  $\sum_{b \in \Omega} \{ \mu_\infty(b) \times \{ \cdot \} \}$  is the expected value of the term inside the inner curly brackets, where the expectation is taken over the limiting distribution of the industry state.

## 4 Results from a Broader Set of Parameterizations

The patterns described in Section 5 are further confirmed by the results from a broader set of parameterizations. Table 1 reports the changes in network compatibility and average price when  $k$  is reduced from 3 to 0 under the endogenous compatibility regime, for  $\theta \in \{2, 3, 4\}$ ,  $v_0 \in \{-5, -4, -3\}$ , and  $\delta \in \{0.05, 0.06, 0.07, 0.08\}$ . The table shows that as the switching cost is reduced from 3 to 0, the firms substantially reduce the compatibility between their networks, and the average price goes down: the change in the probability of compatible networks ranges from -0.23 to -0.79, with a median of -0.56 (the percentage change ranges from -62% to -100%, with a median of -98%), and the change in the average price ranges from -0.57 to -1.71, with a median of -1.20 (the percentage change ranges from -28% to -56%, with a median of -46%).

For the same set of parameterizations, Table 2 reports the changes in PS and CS when  $k$  is reduced from 3 to 0 under the endogenous compatibility regime. The table shows that as the switching cost is reduced from 3 to 0, PS goes down: the change in PS ranges from -0.45 to -1.57, with a median of -1.09 (the percentage change ranges from -24% to -55%, with a median of -45%). At the same time, CS either goes down or increases slightly: the change in CS ranges from -4.24 to 6.44, with a median of -1.50 (78% of the changes are negative).<sup>16</sup>

Lastly, Table 3 reports the change in TS when  $k$  is reduced from 3 to 0. Starting from  $k = 3$  under the endogenous compatibility regime, two sets of changes are reported. First, if  $k$  is reduced from 3 to 0 while keeping the endogenous compatibility regime, then the change in TS is ambiguous

<sup>15</sup>Recall that for the consumers whose products died and who do not make a purchasing decision, we assume that they use the outside good.

<sup>16</sup>Because utility is an ordinal concept, the absolute level of utility and consequently the absolute level of consumer surplus cannot be measured; only the variation is measurable. Therefore, in Tables 2 and 3, only changes, and not percentage changes, are reported for CS and TS. Furthermore, since the quality of the outside good,  $v_0$ , is parameterized to be less than zero, expected consumer surplus and therefore expected total surplus can be negative, as is reflected in Tables 2 and 3.

and there are small efficiency gains at best: the change in TS ranges from -5.31 to 5.51, with a median of -2.84 (86% of the changes are negative). However, if the reduction in  $k$  is accompanied by the imposition of the mandatory compatibility regime, then there are sizable efficiency gains: the change in TS ranges from 4.15 to 22.25, with a median of 8.36 (100% of the changes are positive).

## 5 A More General Form of Network Effect

In this Appendix, we consider a more general form of the consumer's utility from the network effect,  $\theta g(b_i + wd_1d_2b_{-i})$ , where  $w \in (0, 1]$  is the weight parameter.

The main specification analyzed in this paper, in which the consumer derives the same benefit from each network when the two networks are made compatible, corresponds to  $w = 1$  (full compatibility). In comparison, when  $w < 1$ , firm  $i$ 's consumer enjoys a smaller benefit from firm  $i$ 's competitor's network than from firm  $i$ 's network (partial compatibility). We consider the following values of  $w$  in this robustness check:  $w \in \{0.75, 0.5, 0.25\}$ .

The results from this robustness check are presented in Figures 7a and 7b, and they show that the main findings of the paper are robust to changing the value of  $w$ .

The left column of panels in Figure 7a show the type of equilibrium that occurs for different combinations of  $\theta$  (strength of network effect) and  $k$  (switching cost). Comparison between these panels and their counterpart in Figure 5 in the paper (which has  $w = 1$ ) shows that changing the value of  $w$  has minimal effect on the type of equilibrium that occurs: for most of the parameterizations, the type of equilibrium remains unchanged as we change the value of  $w$ .

The intuition for the above finding is that when the magnitude of switching costs is changed, the first-order effect is on the intensity of price competition, and this first-order effect does not hinge on the value of  $w$ . Changes in the firms' compatibility choices are then derived from this first-order effect. In particular, in markets with strong network effects, regardless of the value of  $w$ , at low switching costs the firms compete fiercely for market dominance, whereas at high switching costs they engage in mild competition and focus on harvesting their own locked-in consumers. The effect of switching costs on the firms' compatibility choices is a consequence of the above first-order effect: at low switching costs, as the firms compete for market dominance, the larger firm refuses compatibility in order to maintain its advantage over the smaller firm, in an effort to achieve and maintain market dominance (Tipping equilibrium). At high switching costs, as the firms engage in mild competition and focus on harvesting their own locked-in consumers, they choose to make their products compatible which increases the values of their products relative to the outside good (Compatibility equilibrium).

A similar intuition applies to markets with weak network effects. The only difference is that in that case, without the increasing returns associated with strong network effects, there is a Rising equilibrium instead of a Tipping equilibrium at low switching costs.

The above effects operate regardless of the value of  $w$ . Therefore, as we change the value of  $w$ , the effects of switching costs on the intensity of competition as well as on the firms' compatibility choices are largely unaffected, and the type of equilibrium that occurs in the market remains largely unchanged.

The right column of panels in Figure 7a plot the probability of compatible networks, the market concentration, and the average price for  $k \in \{0, 0.5, \dots, 3\}$  while holding  $\theta = 3$ . These panels show that the results remain qualitatively the same when we change the value of  $w$ . In particular, they show that for all the different values of  $w$  considered, the switch from Tipping equilibrium to Compatibility equilibrium occurs between  $k = 1.5$  and  $k = 2$ , where the probability of compatible networks increases significantly while the market concentration drops significantly.

In unreported results, I zoom in on the shorter interval of  $[1.5, 2]$  for  $k$ , and examine  $k \in \{1.5, 1.52, 1.54, \dots, 2\}$ . I find that as we decrease the value of  $w$  (from 1, 0.75, 0.5 to 0.25), the switch from Tipping equilibrium to Compatibility equilibrium occurs at slightly higher switching costs. For example, when  $w = 1$ , the switch from Tipping equilibrium to Compatibility equilibrium occurs between  $k = 1.64$  and  $k = 1.66$ , whereas when  $w = 0.5$ , the switch occurs between  $k = 1.7$  and  $k = 1.72$ . These results show that changing the value of  $w$  can affect the type of equilibrium that occurs in the market, but its effect is small, relative to the effects of the two main parameters in the model,  $\theta$  and  $k$ .

Figure 7b presents the effects of a reduction in the switching cost  $k$  on compatibility, average price, PS, CS, and TS, under different values of  $w$ . As  $w$  becomes smaller, making the networks compatible makes a smaller impact, and the difference between the mandatory compatibility (MC) regime and the prohibited compatibility (PC) regime becomes smaller (in the extreme case, if  $w = 0$ , making the networks “compatible” makes no difference and the MC and PC regimes coincide). The results in Figure 7b show that for each of the  $w$  values considered, as  $k$  is reduced from 3 to 0, the probability of compatible networks first falls substantially between  $k = 3$  and  $k = 1$ , then levels off between  $k = 1$  and  $k = 0$  (see the first row of panels). The efficiency losses from the firms reducing the compatibility between their networks offset (at least partially) the efficiency gains from the reduction in the switching cost, and as a result, when  $k$  is reduced from 3 to 0, TS either decreases or has a small increase (see the last row of panels in Figure 7b). These results are consistent with the ones obtained from the main specification in the paper, in which  $w = 1$  (Figure 6 in the paper).

In sum, the results from this robustness check show that the main findings of this paper are robust to changing the value of  $w$  and modeling partial compatibility instead of full compatibility.

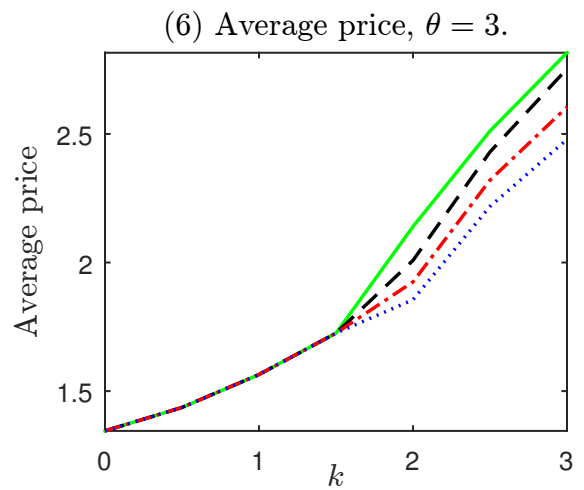
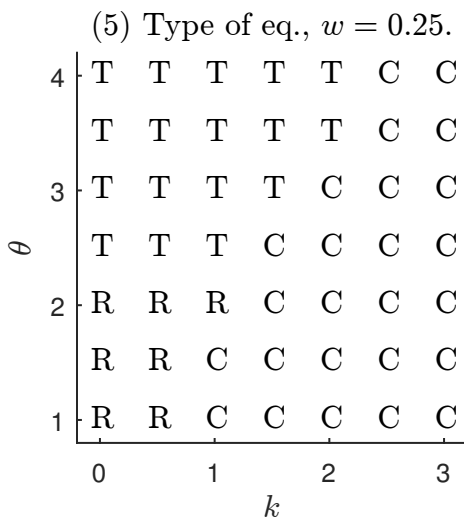
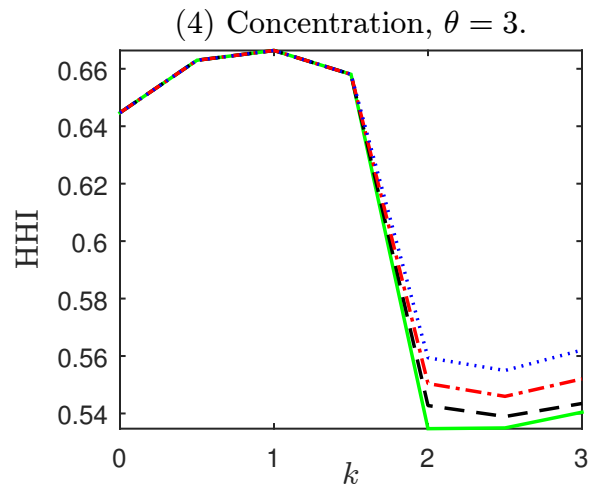
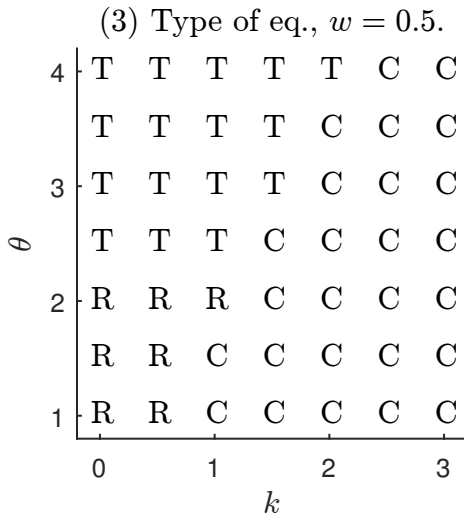
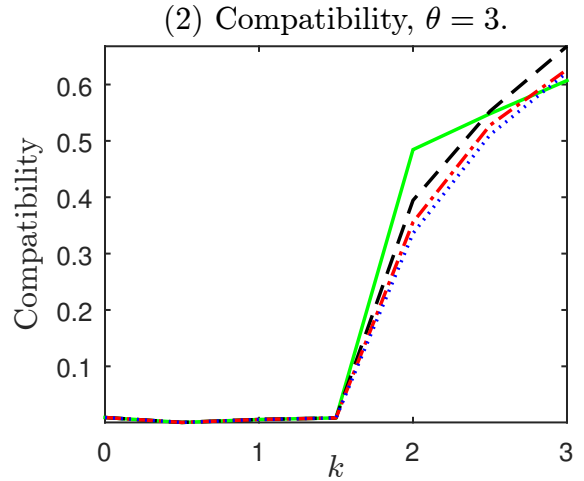
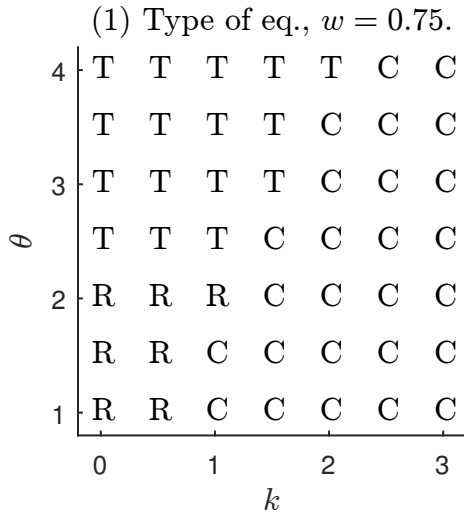

Figure 7a. Robustness check with respect to  $w$ .  $v_0 = -4$ ,  $\delta = 0.06$ .

Solid lines:  $w = 1$ . Dashed lines:  $w = 0.75$ . Dash-dot lines:  $w = 0.5$ . Dotted lines:  $w = 0.25$ .



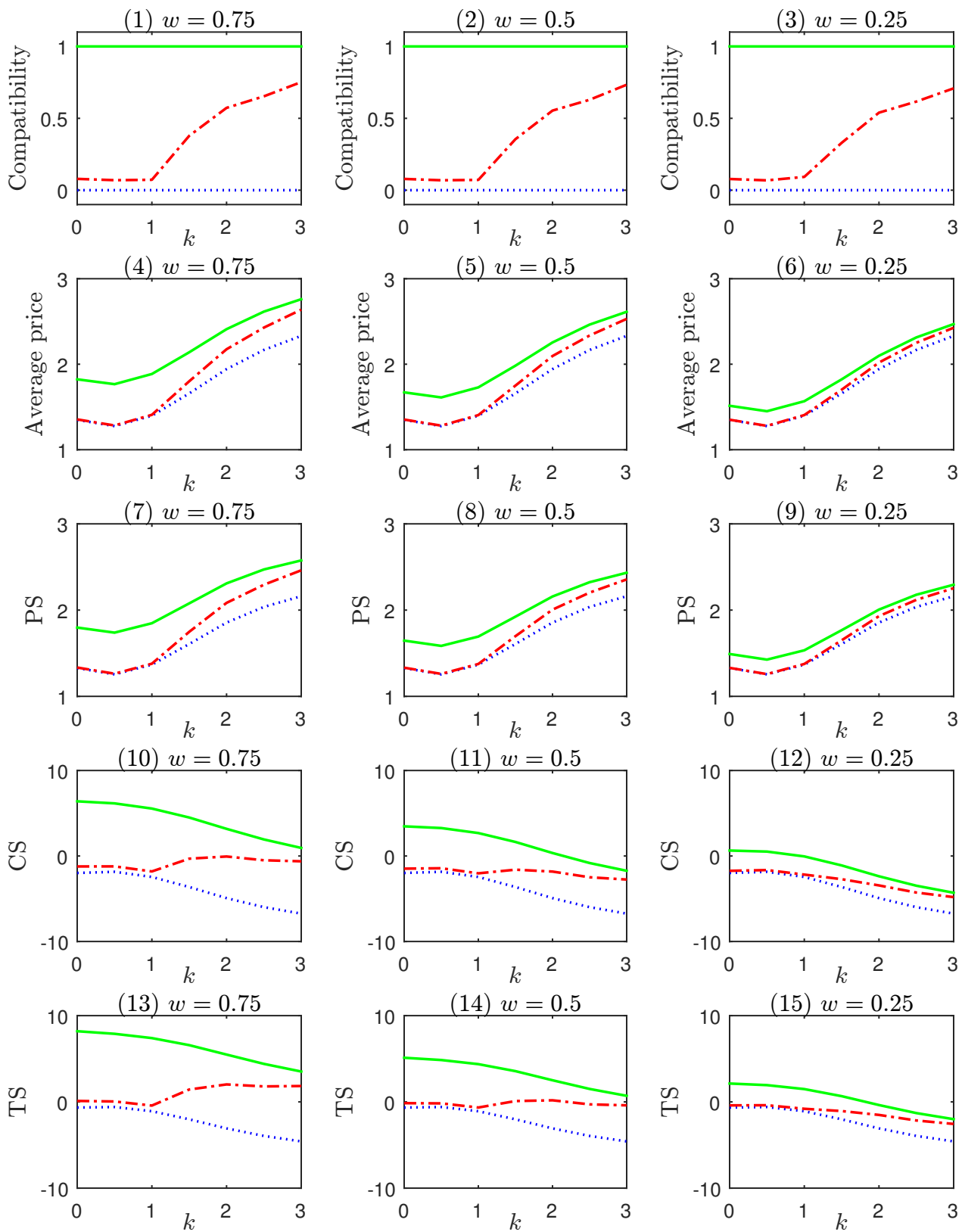

Figure 7b. Robustness check with respect to  $w$ .  $v_0 = -4$ ,  $\delta = 0.06$ ,  $\theta = 2$ .  
Solid lines: mandatory compatibility (MC). Dash-dot lines: endogenous compatibility (EC).  
Dotted lines: prohibited compatibility (PC).

Table 1. Changes in compatibility and average price when  $k$  is reduced from 3 to 0 under Endogenous Compatibility (EC) regime.

$\theta$	$v_0$	$\delta$	Compatibility				Average Price			
			(A) $k = 3,$ EC	(B) $k = 0,$ EC	Change from (A) to (B)	% change from (A) to (B)	(A) $k = 3,$ EC	(B) $k = 0,$ EC	Change from (A) to (B)	% change from (A) to (B)
2	-5	0.05	0.56	0.02	-0.55	-97%	3.07	1.36	-1.71	-56%
		0.06	0.61	0.08	-0.53	-87%	3.04	1.36	-1.68	-55%
		0.07	0.64	0.09	-0.55	-86%	2.82	1.42	-1.40	-50%
		0.08	0.54	0.10	-0.45	-82%	2.55	1.46	-1.08	-43%
	-4	0.05	0.67	0.07	-0.60	-90%	2.85	1.28	-1.57	-55%
		0.06	0.76	0.08	-0.68	-90%	2.75	1.36	-1.39	-51%
		0.07	0.74	0.09	-0.66	-88%	2.53	1.41	-1.12	-44%
		0.08	0.72	0.10	-0.62	-86%	2.36	1.46	-0.90	-38%
	-3	0.05	0.75	0.07	-0.68	-90%	2.50	1.29	-1.21	-48%
		0.06	0.85	0.08	-0.76	-90%	2.36	1.35	-1.01	-43%
		0.07	0.83	0.29	-0.54	-65%	2.19	1.45	-0.74	-34%
		0.08	0.80	0.30	-0.49	-62%	2.06	1.48	-0.57	-28%
3	-5	0.05	0.36	0.00	-0.36	-100%	2.94	1.49	-1.45	-49%
		0.06	0.48	0.01	-0.47	-99%	3.00	1.36	-1.64	-55%
		0.07	0.53	0.02	-0.51	-97%	2.80	1.24	-1.56	-56%
		0.08	0.43	0.07	-0.36	-84%	2.46	1.16	-1.30	-53%
	-4	0.05	0.46	0.00	-0.46	-100%	2.86	1.47	-1.39	-48%
		0.06	0.61	0.01	-0.60	-98%	2.82	1.35	-1.47	-52%
		0.07	0.70	0.02	-0.68	-97%	2.65	1.21	-1.44	-54%
		0.08	0.66	0.07	-0.58	-89%	2.41	1.16	-1.24	-52%
	-3	0.05	0.56	0.00	-0.56	-100%	2.63	1.44	-1.19	-45%
		0.06	0.77	0.01	-0.76	-99%	2.57	1.30	-1.27	-49%
		0.07	0.82	0.03	-0.79	-96%	2.39	1.15	-1.24	-52%
		0.08	0.78	0.08	-0.70	-90%	2.19	1.18	-1.02	-46%
4	-5	0.05	0.23	0.00	-0.23	-100%	2.88	1.92	-0.96	-33%
		0.06	0.42	0.00	-0.42	-100%	2.91	1.61	-1.30	-45%
		0.07	0.37	0.00	-0.37	-100%	2.61	1.43	-1.18	-45%
		0.08	0.26	0.00	-0.26	-100%	2.23	1.29	-0.94	-42%
	-4	0.05	0.25	0.00	-0.25	-100%	2.87	1.91	-0.96	-33%
		0.06	0.46	0.00	-0.46	-100%	2.74	1.60	-1.14	-42%
		0.07	0.61	0.00	-0.61	-100%	2.65	1.42	-1.23	-46%
		0.08	0.57	0.00	-0.57	-100%	2.36	1.27	-1.08	-46%
	-3	0.05	0.34	0.00	-0.34	-100%	2.70	1.87	-0.82	-31%
		0.06	0.62	0.00	-0.62	-100%	2.63	1.57	-1.06	-40%
		0.07	0.74	0.00	-0.74	-100%	2.50	1.38	-1.11	-45%
		0.08	0.76	0.01	-0.75	-98%	2.31	1.23	-1.08	-47%

Table 2. Changes in producer surplus (PS) and consumer surplus (CS) when  $k$  is reduced from 3 to 0 under Endogenous Compatibility (EC) regime.

$\theta$	$v_0$	$\delta$	Producer Surplus				Consumer Surplus		
			(A) $k = 3,$ EC	(B) $k = 0,$ EC	Change from (A) to (B)	% change from (A) to (B)	(A) $k = 3,$ EC	(B) $k = 0,$ EC	Change from (A) to (B)
2	-5	0.05	2.92	1.35	-1.57	-54%	10.87	9.72	-1.16
		0.06	2.91	1.35	-1.57	-54%	-2.79	-4.12	-1.32
		0.07	2.73	1.41	-1.32	-48%	-16.38	-17.85	-1.47
		0.08	2.48	1.45	-1.02	-41%	-28.44	-29.23	-0.79
	-4	0.05	2.65	1.27	-1.38	-52%	13.85	10.72	-3.14
		0.06	2.57	1.34	-1.23	-48%	1.48	-0.97	-2.45
		0.07	2.38	1.39	-1.00	-42%	-11.07	-12.76	-1.69
		0.08	2.23	1.43	-0.81	-36%	-21.04	-22.39	-1.35
	-3	0.05	2.22	1.25	-0.97	-44%	15.76	11.67	-4.09
		0.06	2.11	1.30	-0.82	-39%	4.37	1.47	-2.90
		0.07	1.97	1.39	-0.58	-30%	-6.45	-6.57	-0.11
		0.08	1.86	1.41	-0.45	-24%	-14.82	-14.71	0.11
3	-5	0.05	2.85	1.48	-1.37	-48%	20.70	22.38	1.67
		0.06	2.92	1.36	-1.57	-54%	6.55	6.17	-0.38
		0.07	2.74	1.23	-1.51	-55%	-8.27	-9.80	-1.53
		0.08	2.42	1.15	-1.26	-52%	-22.32	-23.49	-1.17
	-4	0.05	2.73	1.46	-1.27	-46%	24.62	23.97	-0.64
		0.06	2.69	1.33	-1.36	-51%	11.74	9.50	-2.24
		0.07	2.55	1.20	-1.35	-53%	-1.65	-4.51	-2.86
		0.08	2.32	1.15	-1.17	-50%	-13.85	-16.46	-2.61
	-3	0.05	2.43	1.41	-1.02	-42%	28.06	25.17	-2.89
		0.06	2.39	1.27	-1.12	-47%	16.48	12.29	-4.19
		0.07	2.22	1.12	-1.11	-50%	3.75	0.22	-3.53
		0.08	2.04	1.14	-0.90	-44%	-6.73	-9.99	-3.26
4	-5	0.05	2.84	1.92	-0.93	-33%	31.71	38.15	6.44
		0.06	2.87	1.61	-1.26	-44%	16.26	17.43	1.17
		0.07	2.58	1.43	-1.15	-45%	-1.86	-1.62	0.25
		0.08	2.20	1.29	-0.92	-42%	-17.70	-16.66	1.05
	-4	0.05	2.77	1.90	-0.88	-32%	33.57	39.77	6.20
		0.06	2.67	1.59	-1.08	-40%	20.84	20.81	-0.03
		0.07	2.59	1.41	-1.18	-46%	6.71	3.75	-2.96
		0.08	2.30	1.26	-1.04	-45%	-7.29	-9.55	-2.25
	-3	0.05	2.55	1.84	-0.71	-28%	38.89	41.02	2.13
		0.06	2.50	1.54	-0.96	-38%	26.04	23.72	-2.33
		0.07	2.38	1.35	-1.03	-43%	12.85	8.61	-4.24
		0.08	2.20	1.20	-1.00	-46%	1.04	-2.73	-3.77

Table 3. Change in total surplus (TS) when  $k$  is reduced from 3 to 0 under Endogenous Compatibility (EC) and Mandatory Compatibility (MC) regimes.

$\theta$	$v_0$	$\delta$	(A) $k = 3,$ EC	(B) $k = 0,$ EC	Change from (A) to (B)	(C) $k = 0,$ MC	Change from (A) to (C)
2	-5	0.05	13.79	11.07	-2.73	23.69	9.90
		0.06	0.12	-2.77	-2.89	8.27	8.15
		0.07	-13.65	-16.44	-2.79	-7.95	5.70
		0.08	-25.96	-27.77	-1.81	-21.31	4.66
	-4	0.05	16.50	11.98	-4.52	25.16	8.66
		0.06	4.05	0.37	-3.68	11.32	7.28
		0.07	-8.68	-11.37	-2.69	-3.01	5.68
		0.08	-18.81	-20.96	-2.15	-14.63	4.18
	-3	0.05	17.97	12.91	-5.06	26.06	8.09
		0.06	6.48	2.77	-3.71	13.51	7.03
		0.07	-4.48	-5.18	-0.70	1.01	5.49
		0.08	-12.96	-13.30	-0.34	-8.81	4.15
3	-5	0.05	23.55	23.86	0.30	40.29	16.73
		0.06	9.48	7.53	-1.95	21.94	12.47
		0.07	-5.53	-8.56	-3.03	2.71	8.24
		0.08	-19.90	-22.34	-2.43	-13.01	6.89
	-4	0.05	27.34	25.43	-1.91	41.96	14.62
		0.06	14.44	10.83	-3.60	25.28	10.85
		0.07	0.90	-3.31	-4.21	7.95	7.05
		0.08	-11.53	-15.31	-3.77	-6.07	5.46
	-3	0.05	30.48	26.58	-3.91	43.29	12.81
		0.06	18.87	13.56	-5.31	28.06	9.19
		0.07	5.97	1.33	-4.64	12.50	6.53
		0.08	-4.69	-8.84	-4.16	0.16	4.85
4	-5	0.05	34.56	40.07	5.51	56.81	22.25
		0.06	19.13	19.04	-0.09	35.52	16.39
		0.07	0.72	-0.19	-0.90	13.28	12.56
		0.08	-15.50	-15.37	0.13	-4.78	10.72
	-4	0.05	36.34	41.67	5.33	58.60	22.25
		0.06	23.51	22.40	-1.10	39.04	15.53
		0.07	9.29	5.15	-4.14	18.72	9.43
		0.08	-4.99	-8.29	-3.29	2.34	7.33
	-3	0.05	41.44	42.86	1.42	60.20	18.76
		0.06	28.54	25.26	-3.28	42.22	13.67
		0.07	15.23	9.96	-5.26	23.71	8.48
		0.08	3.24	-1.53	-4.77	8.96	5.72